

AutoChem™ II 2920

The Catalyst Characterization Laboratory



Catalyst Characterization

AutoChem II 2920 Chemisorption Analyzer

A Catalyst Characterization Laboratory in a Single Analytical Instrument

Optimum design and efficient utilization of catalysts require a thorough understanding of the surface structure and surface chemistry of the catalytic material. Chemical adsorption (chemisorption) analyses can provide much of the information needed to evaluate catalyst materials in the design and production phases, as well as after a period of use. The chemical adsorption isotherm reveals information about the active surface of a material and has been employed for many years as a standard analytical tool for the evaluation of catalysts. In addition, temperature-programmed reaction techniques have emerged as an indispensable companion to chemisorption isotherm analyses in many areas of industry and research.

Micromeritics' AutoChem II 2920 Chemisorption Analyzer is a fully automated instrument capable of conducting a comprehensive array of highly precise chemical adsorption and temperature-programmed reaction studies. The instrument enables the researcher to obtain valuable information about the physical properties of catalysts, catalyst support, and a variety of other materials. Researchers can investigate active metal surface area, surface acidity, distribution and strength of active sites, BET surface area, and more. The AutoChem II performs pulse chemisorption, temperature-programmed reduction (TPR), desorption (TPD), oxidation (TPO), and reaction analyses. Multiple experiments can be run using the same sample.



Wide Variety of Features and Benefits

- Four internal temperature-controlled zones can be heated independently up to 150 °C. This prevents condensation in the flow path and allows studies to be performed with vapors.
- Low internal plumbing volume assures high resolution, fast detector response, and reduces error when calculating gas volumes.
- Highly sensitive linear thermal conductivity detector (TCD) assures the calibration volume remains constant over the full range of peak amplitudes so the area under the peak is directly proportional to the volume of gas reacted.
- Four high-precision mass flow controllers provide extremely accurate, programmable gas control. This assures a stable baseline and accurate determination of gas volumes.
- Corrosion-resistant detector filaments are compatible with most destructive gases and reduce the likelihood of filament oxidation.
- Clamshell furnace can heat the quartz sample reactor to 1100 °C. Any number of ramp rates and sequences facilitate customized experiments. The KwikCool feature cools the furnace temperature rapidly down to near ambient, reducing analysis time and increasing throughput.
- Four gas inlets each for the preparation, carrier, and loop gases permit four-gas sequential experiments, such as TPR/TPO cycles.
- Mass spectrometer port and software integration allows virtually simultaneous detection on both the thermal conductivity detector and mass spectrometer.
- Optional Vapor Generator permits analysis using vaporized liquids in an inert carrier stream.
- Optional CryoCooler enables the start of an analysis at subambient temperature.

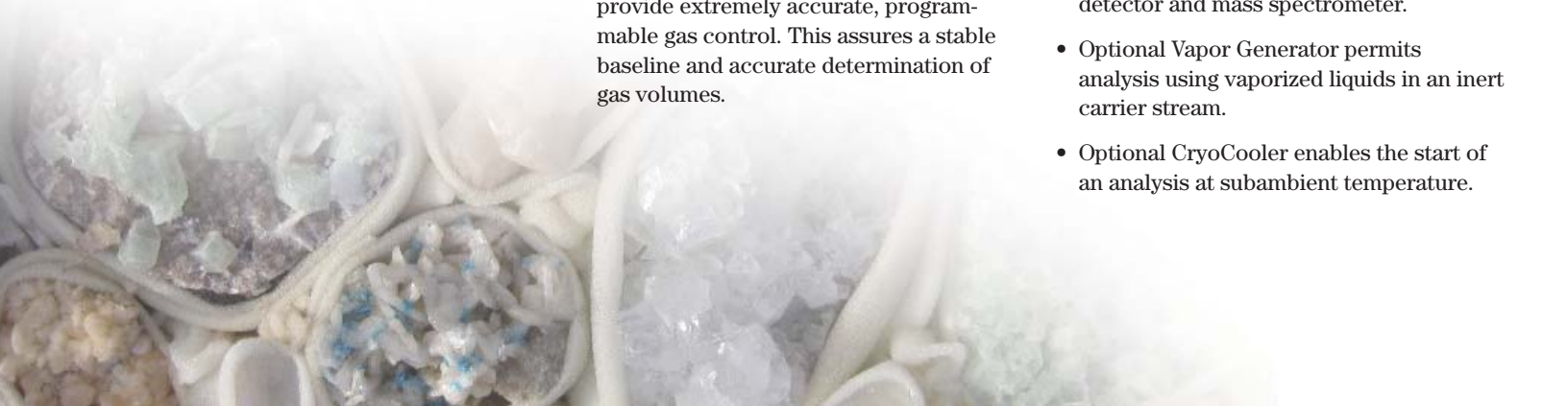

Typical AutoChem II 2920 Applications

Catalysts

The active surface area and porous structure of catalysts have a great influence on production rates. Limiting the pore size allows only molecules of desired sizes to enter and leave; creating a selective catalyst that will produce primarily the desired product. Chemisorption experiments are valuable for the selection of catalysts for a particular purpose, qualification of catalyst vendors, and the testing of catalyst performance over time to establish when the catalyst should be reactivated or replaced.

Fuel Cells

Platinum-based catalysts including Pt/C, PtRu/C, and PtRuIr/C are often characterized by temperature-programmed reduction to determine the number of oxide phases and pulse chemisorption to calculate:

- Metal surface area
- Metal dispersion
- Average crystallite size

Partial Oxidation

Manganese, cobalt, bismuth, iron, copper, and silver catalysts used for the gas-phase oxidation of ammonia, methane, ethylene, and propylene are characterized using:

- Temperature-programmed oxidation
- Temperature-programmed desorption
- Heat of desorption of oxygen
- Heat of dissociation of oxygen

Catalytic Cracking

Acid catalysts such as zeolites are used to convert large hydrocarbons to gasoline and diesel fuel. The characterization of these materials includes:

- Ammonia chemisorption
- Temperature-programmed desorption of ammonia
- Temperature-programmed decomposition of alkyl amines
- Temperature-programmed desorption of aromatic amines



Catalytic Reforming

Catalysts containing platinum, rhenium, tin, etc. on silica, alumina, or silica-alumina are used for the production of hydrogen, aromatics, and olefins. These catalysts are commonly characterized to determine:

- Metal surface area
- Metal dispersion
- Average crystallite size

Isomerization

Catalysts such as small-pore zeolites (mordenite and ZSM-5) containing noble metals (typically platinum) are used to convert linear paraffins to branched paraffins. This increases the octane number and value for blending gasoline and improves the low temperature flow properties of oil. The characterization of these materials includes:

- Temperature-programmed reduction
- Pulse chemisorption

Hydrocracking, Hydrodesulfurization, and Hydrodenitrogenation

Hydrocracking catalysts typically composed of metal sulfides (nickel, tungsten, cobalt, and molybdenum) are used for processing feeds containing polycyclic aromatics that are not suitable for typical catalytic cracking processes. Hydrodesulfurization and hydrodenitrogenation are used for removing sulfur and nitrogen respectively from petroleum feeds. The characterization of these materials includes:

- Temperature-programmed reduction
- Oxygen pulse chemisorption

Fischer-Tropsch Synthesis

Cobalt, iron, etc. based catalysts are used to convert syngas (carbon monoxide and hydrogen) to hydrocarbons larger than methane. These hydrocarbons are rich in hydrogen and do not contain sulfur or nitrogen. The characterization of these materials includes:

- Temperature-programmed desorption
- Pulse chemisorption

Innovative Design

AutoChem II 2920 Hardware Advantages

The AutoChem II features stainless-steel construction, fully automated flow and pressure control, an embedded microprocessor with real-time control, and an intuitive graphical user interface for reactor control. A temperature-controlled, stainless-steel flow path provides an inert and stable operating environment, and reduces the potential for condensation in the flow path. The embedded microprocessor allows the AutoChem II to operate with real-time control; this provides enhanced stability by separating the AutoChem control from a PC or workstation.

- **Twelve gas inlets** (4 each for prep, carrier, and analysis) provide the capability to perform sequential experiments such as TPR/TPO cycle experiments.
- Equipped with **four high-precision, independently calibrated mass flow controllers** providing extremely accurate, programmable gas control. The ability to control gas flow with accuracy assures a stable baseline and accurate determination of gas volumes.
- Analysis gas may be introduced to the carrier stream by a **precision automated loop**. A calibrated, conveniently located septum is also provided through which analysis gas can be injected by means of a calibrated syringe.
- **Thermal conductivity detector (TCD)** is capable of detecting minute differences in the concentration of gases flowing into and out of the sample reactor. Its corrosion-resistant filaments are operated at constant temperature to prevent thermal runaway, which can destroy filaments in other systems.
- A **clamshell furnace** can heat the quartz sample reactor up to 1100 °C. The AutoChem II 2920 permits any number of ramp rates and sequences

Cold Trap to remove condensable species – the Cold Trap is easily bypassed to improve response time



Vapor Generator featuring two zones to ensure a saturated vapor is produced

Easy-to-open clamshell furnace with a range of ambient to 1100 °C – an optional CryoCooler is available to cool the sample to -100 °C

to facilitate customized experiments. The included KwikCool feature permits cooling the furnace temperature rapidly down to near ambient, reducing analysis time and increasing throughput. With the **CryoCooler option**, analysis temperatures can be ramped over the range of -100 °C to 1100 °C.

- **Four internal temperature-controlled zones** can be heated independently of each other to as much as 150 °C. This prevents condensation in the flow path and allows studies to be performed with vapors.
- The extremely **low volume of the internal plumbing** minimizes peak spreading and significantly enhances peak resolution. Furthermore, it reduces the time lag between the sample reactions and the corresponding detector response.

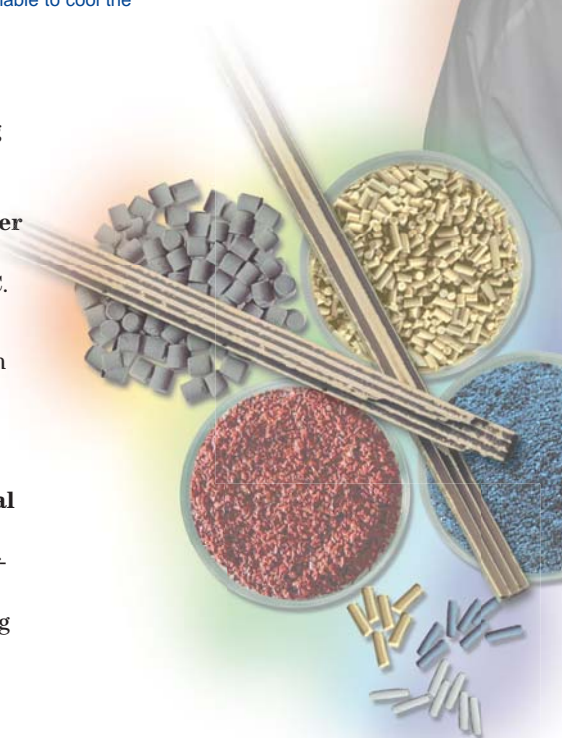

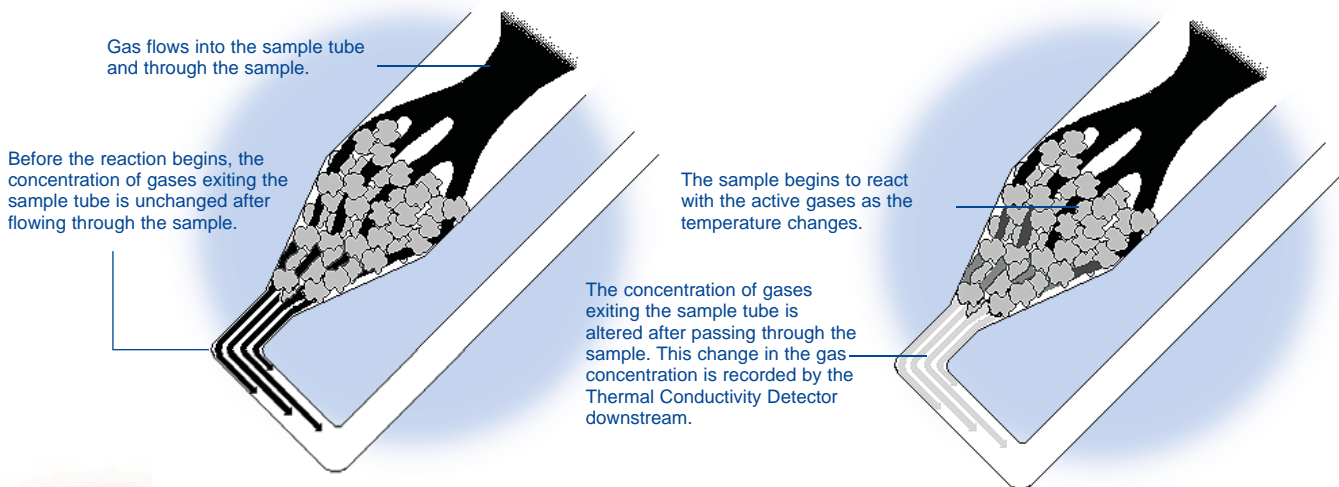

The AutoChem II Technique

During the TPR, a metal oxide reacts with hydrogen to form a pure metal. This reaction is referred to as a reduction; for example, TPR of a catalyst containing platinum. Argon, which has a very low relative thermal conductivity, is used as a component in the carrier gas. It is blended in a fixed proportion with hydrogen, the reducing gas with a much higher thermal conductivity. Then the gas mixture flows through the analyzer, through the sample, and past the detector. When the hydrogen and argon gas blend begins flowing over the sample, a baseline reading is established by the detector. This baseline is established at a low enough temperature so that no reduction of the sample occurs. The baseline level indicated by the detector is that of the thermal conductivity of the two gases in their fixed proportion. In other words, the proportion of gases flowing over the detector is the same as the proportion of gases entering the analyzer because at the low temperature there is no interaction with the sample.

The temperature is then raised and, when a critical temperature is reached, hydrogen atoms in the gas flow react with the sample, forming H_2O molecules. The H_2O molecules are removed from the gas stream using a cold trap. As a result, the amount of hydrogen in the argon/hydrogen gas blend inside the analyzer decreases, and the proportion between the two gases shifts in the direction of argon, as does the mixture's thermal conductivity. Since argon has a lower thermal conductivity than hydrogen, the mixture's thermal conductivity consequently decreases. The flowing gas removes heat from the filament more slowly, requiring less electricity to maintain a constant filament temperature. The instrument records the electrical demand as it changes (this is called the detector signal). The detector signal is recorded continuously over a range of temperatures. When these readings are graphed, the data form one or more peaks. Peaks can be positive or negative.

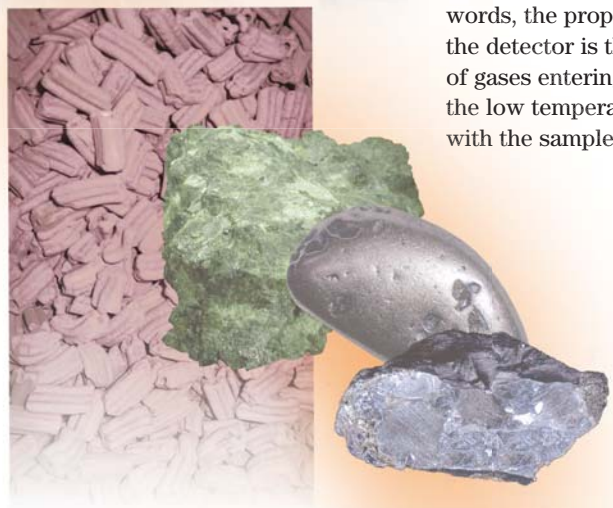

Software and Reporting Versatility

AutoChem II 2920 Software Features

The easy-to-use AutoChem II software utilizes a Windows® interface that includes Wizards and applications to help plan, launch, and control the analysis. It provides all the convenient features you are accustomed to when using Windows-based programs; point-and-click operations, pull-down menus, access to multiple printers and network drives, multitasking capability, and much more. You can collect, organize, archive and reduce raw data, and store standardized sample information and analysis conditions for easy access during later applications. Finished reports may be generated to screen, paper, or data transfer channels. Features include cut-and-paste graphics, scalable-and-editable graphs, and customizable reports.

- Set up analysis protocol sequencing from any number of preprogrammed experiments or create a customized sequence. The user can easily select the pretreatment and analysis task and specify criteria such as temperature ramp rates, gas flow rates, and data measurement intervals in the desired sequence. Modifications may be made to the analysis protocol at any time, even during analysis.
- The instrument schematic screen displays the instrument's current operating status, including the availability of analysis and pretreatment gases and vapors, direction of the gas flow, and TCD reading. It also allows the operator to assume manual control of the instrument if desired.
- One computer can control two AutoChem analyzers of the same or different model making efficient use of valuable lab space. Other types of Micromeritics instruments can also be connected.
- Numerous plots can be overlaid for easy comparison of different samples or for comparison of different data reduction techniques applied to the same sample.
- Exportable data tables provide for merging and comparing data from other sources in a single spreadsheet file.

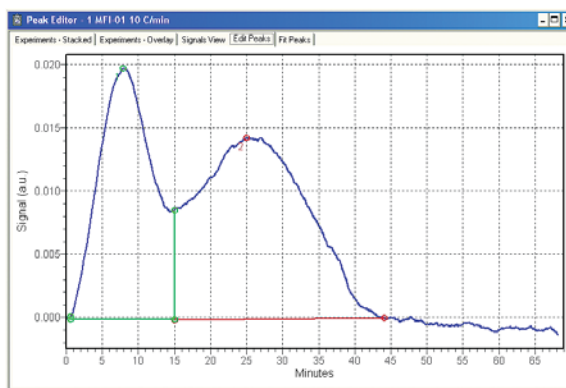
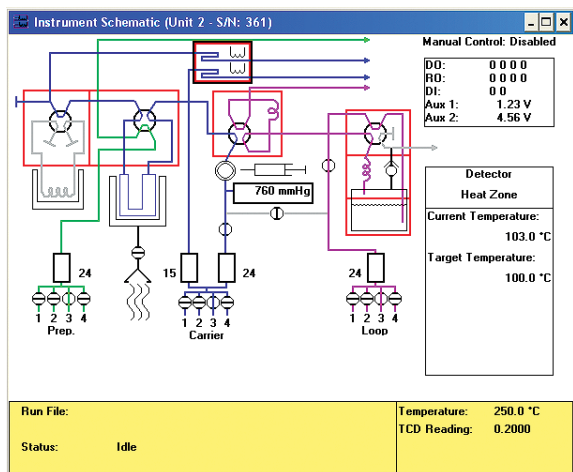

A full-feature peak editor and integration package is included with the AutoChem II. This easy-to-use package provides a rapid method for evaluating common temperature-programmed and dynamic adsorption data.

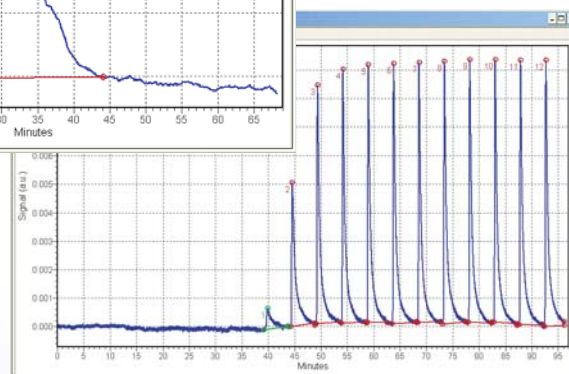

The AutoChem II features 316 stainless-steel construction. This microreactor features a simple-to-use scripting language to allow the rapid development of standard and custom applications. Contact your local Micromeritics Sales and Support representative for custom configurations and options for enhanced corrosion resistance.

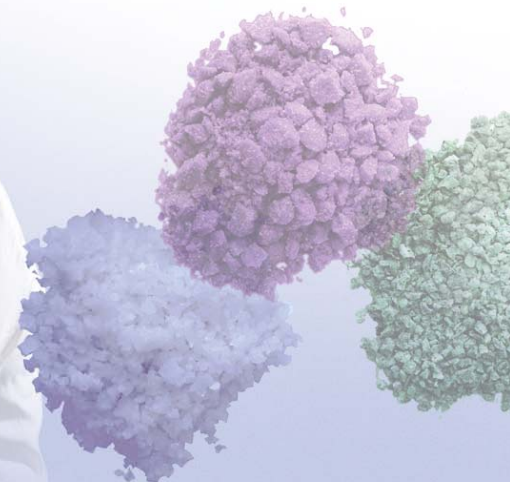

Data Reduction and Reporting

Powerful Peak Editor

Fully integrated, interactive peak editor package enables the user to evaluate results quickly and easily, edit peaks, and produce reports that reflect specific needs. Adjusting peak boundaries is a matter of simply pointing and clicking. The Peak Editor can also be used to deconvolute overlapping peaks. The peak deconvolution is a simple-to-use option on the peak space editor that allows the user to maximize the information.

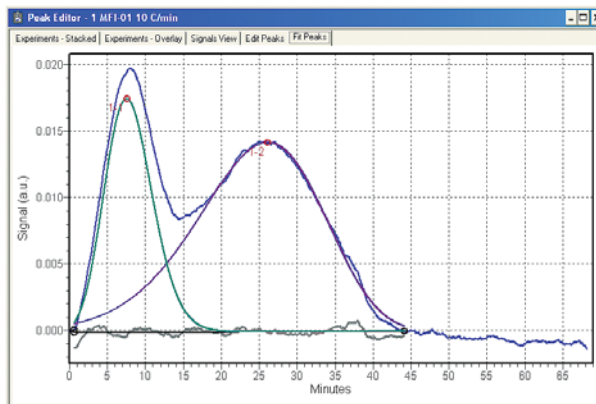

In addition to standard peak integration, peak fitting is also included to allow effective separation and modeling of convolved signals.

The AutoChem II Also Includes

- Ten user-configurable graphical reports
- BET, Langmuir, and total pore volume
- Pulse chemisorption, % dispersion, metal surface area, and crystallite size
- First-order kinetics, heat of desorption, and activation energy
- Integration of mass spectrometer data files

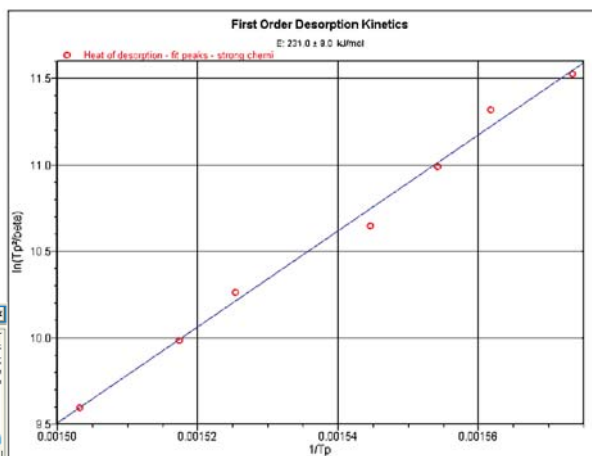

The AutoChem II features a full report system that includes calculations for: metal dispersion, active metal surface area, active particle diameter (crystallite size), and activation energy via first-order kinetic models.

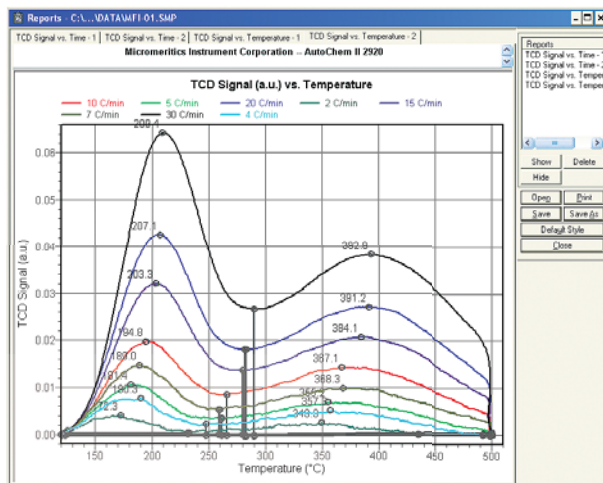

| Pulse Chemisorption Analysis Summary | | | | | |
|--------------------------------------|----------------------------|---------------|----------------------|--|------------------------------|
| Element | Percent of Sample Mass (%) | Atomic Weight | Stoichiometry Factor | Atomic Cross-Sectional Area (nm ²) | Density (g/cm ³) |
| platinum | 0.5000 | 195.090 | 0.667 | 0.0800 | 21.450 |

Active Loop Volume at 110.8 °C: 0.01522 cm³ STP
 Cumulative Quantity: 0.29186 cm³ STP
 Metal Dispersion: 33.8680%
 Metallic Surface Area: 0.4185 m²/g sample
 Metallic Surface Area: 83.6976 m²/g metal
 Active Particle Diameter: 3.3420 nm

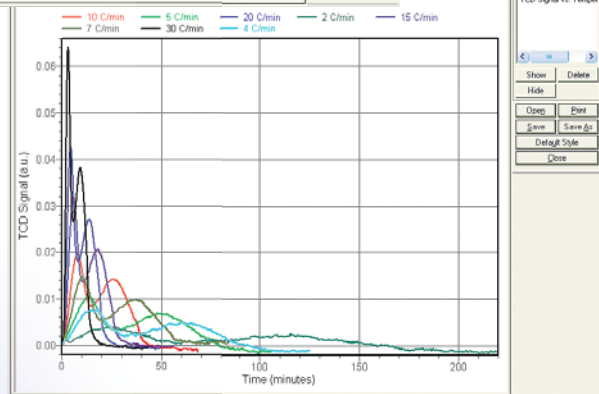

To request a quote or additional product information, visit Micromeritics web site at www.micromeritics.com or contact your local Micromeritics sales representative.



The Science and Technology of Small Particles™

Micromeritics Instrument Corporation
4356 Communications Drive
Norcross, GA 30093
USA

Telephones:

U.S.Sales (770) 662-3633
International Sales (770) 662-3660
Fax (770) 662-3696

Micromeritics China - Beijing Office
Room 1202. No. 1 Building
Shi-Hao Ming-Di (Ten-Mansion)
No. 81 Zi Zhu Yuan Rd.
Hai Dian District
Beijing, P.R. CHINA
Code: 100089

Telephone: (86)-10-68489371
Fax: (86)-10-68489372

Micromeritics France S.A.
Parc Alata
Rue Antoine Laurent Lavoisier
F-60550 Verneuil en Halatte
FRANCE

Telephone (+33) (0)3 44 64 60 80
Fax (+33) (0)3 44 64 60 89

Micromeritics GmbH
Avantis Science Park
Rutherford 108
D-52072 Aachen

Telephone (+49) (0) 241 189 446 0
Fax (+49) (0) 241 189 446 11

Micromeritics Ltd.
Unit 2, Chestnut House
178-182 High Street North
Dunstable, Bedfordshire LU6 1AT
ENGLAND

Telephone (+44) (0)1582-475248
Fax (+44) (0)1582-475252

Micromeritics N.V./S.A.
Eugene Plaskylaan 140B
1030 Brussels
BELGIUM

Telephone (+32) (0)2-743-39-74
Fax (+32) (0)2-743-39-79

Micromeritics SRL
Via W.Tobagi n. 26/7
20068 Peschiera Borromeo, Milano
ITALY

Telephone (+39) (0)255302833
Fax (+39) (0)2553 02843

Micromeritics Japan, G.K.
5F Tokatsu Techno Plaza
501, 5-4-6 Kashiwanoha
Kashiwa, Chiba 277-0882

Japan
Telephone (81)-0-4-7128-5051
Fax (81)-0-4-7128-5054