

AccuPyc[®] III

GAS DISPLACEMENT PYCNOMETER



micromeritics[®]

OPERATOR MANUAL

135-42800-01
Nov 2023
(Rev -)

TRADEMARKS

AccuPyc is a registered trademark of Micromeritics Instrument Corporation.

MicroActive is a trademark of Micromeritics Instrument Corporation.

Micromeritics is a registered trademark of Micromeritics Instrument Corporation.

Teflon is a registered trademark of E. I. DuPont de Nemours Company.

Copyright

The software described in this manual is furnished under a license agreement and may be used or copied only in accordance with the terms of the agreement.

WARRANTY

MICROMERITICS INSTRUMENT CORPORATION warrants for one year from the date of shipment each instrument it manufactures to be free from defects in material and workmanship impairing its usefulness under normal use and service conditions except as noted herein.

Our liability under this warranty is limited to repair, servicing and adjustment, free of charge at our plant, of any instrument or defective parts when returned prepaid to us and which our examination discloses to have been defective. The purchaser is responsible for all transportation charges involving the shipment of materials for warranty repairs. Failure of any instrument or product due to operator error, improper installation, unauthorized repair or alteration, failure of utilities, or environmental contamination will not constitute a warranty claim. The materials of construction used in MICROMERITICS instruments and other products were chosen after extensive testing and experience for their reliability and durability. However, these materials cannot be totally guaranteed against wear and/or decomposition by chemical action (corrosion) as a result of normal use.

Repair parts are warranted to be free from defects in material and workmanship for 90 days from the date of shipment.

No instrument or product shall be returned to MICROMERITICS prior to notification of alleged defect and authorization to return the instrument or product. All repairs or replacements are made subject to factory inspection of returned parts.

MICROMERITICS shall be released from all obligations under its warranty in the event repairs or modifications are made by persons other than its own authorized service personnel unless such work is authorized in writing by MICROMERITICS.

The obligations of this warranty will be limited under the following conditions:

1. Certain products sold by MICROMERITICS are the products of reputable manufacturers, sold under their respective brand names or trade names. We, therefore, make no express or implied warranty as to such products. We shall use our best efforts to obtain from the manufacturer, in accordance with his customary practice, the repair or replacement of such of his products that may prove defective in workmanship or materials. Service charges made by such manufacturer are the responsibility of the ultimate purchaser. This states our entire liability in respect to such products, except as an authorized person of MICROMERITICS may otherwise agree to in writing.
2. If an instrument or product is found defective during the warranty period, replacement parts may, at the discretion of MICROMERITICS, be sent to be installed by the purchaser, e.g., printed circuit boards, check valves, seals, etc.
3. Expendable items, e.g., sample tubes, detector source lamps, indicator lamps, fuses, valve plugs (rotor) and stems, seals and O-rings, ferrules, etc., are excluded from this warranty except for manufacturing defects. Such items which perform satisfactorily during the first 45 days after the date of shipment are assumed to be free of manufacturing defects.

Purchaser agrees to hold MICROMERITICS harmless from any patent infringement action brought against MICROMERITICS if, at the request of the purchaser, MICROMERITICS modifies a standard product or manufactures a special product to the purchaser's specifications.

MICROMERITICS shall not be liable for consequential or other type damages resulting from the use of any of its products other than the liability stated above. This warranty is in lieu of all other warranties, express or implied, including but not limited to, the implied warranties of merchantability or fitness for use.

CORPORATE PROFILE

Micromeritics Instrument Corporation is the world's leading supplier of high-performance systems to characterize particles, powders and porous materials with a focus on physical properties, chemical activity, and flow properties. Our technology portfolio includes: pycnometry, adsorption, dynamic chemisorption, particle size, intrusion porosimetry, powder rheology, and activity testing of catalysts. The company has R&D and manufacturing sites in the USA, UK, and Spain, and direct sales and service operations throughout the Americas, Europe, and Asia. Micromeritics systems are the instruments-of-choice in more than 10,000 laboratories of the world's most innovative companies and prestigious government and academic institutions. Our world-class scientists and responsive support teams enable customer success by applying Micromeritics technology to the most demanding applications. For more information, please visit www.micromeritics.com.

CONTACT US

Micromeritics Instrument Corporation

4356 Communications Drive
Norcross, GA 30093-2901 USA
Phone: 1-770-662-3636
Fax: 1-770-662-3696
www.Micromeritics.com

Instrument Service or Repair

Phone: 1-770-662-3636
International: Contact your local distributor or call 1-770-662-3636
Service.Helpdesk@Micromeritics.com

Micromeritics Application Support

Support@Micromeritics.com

ABOUT THIS MANUAL

The following symbols or icons indicate safety precautions and/or supplemental information and may appear in this manual:



NOTE — Notes contain important information applicable to the topic.



CAUTION — Cautions contain information to help prevent actions that may damage the analyzer or components.



WARNING — Warnings contain information to help prevent actions that may cause personal injury.

GENERAL SAFETY



Do not modify this instrument without the authorization of Micromeritics Service Personnel.

Any piece of laboratory equipment can become dangerous to personnel when improperly operated or poorly maintained. All employees operating and maintaining Micromeritics instruments should be familiar with its operation and should be thoroughly trained and instructed on safety.

- Read the operator manual for any special operational instructions for the instrument.
- Know how the instrument functions and understand the operating processes.



- Wear the appropriate personal protective equipment when operating this instrument — such as eye protection, lab coat, protective gloves, etc.
- When lifting or relocating the instrument, use proper lifting and transporting devices for heavy instruments. Ensure that sufficient personnel are available to assist in moving the instrument. The AccuPyc 1350 weighs approximately 11.5 kg (25.3 lb).
- Always pay attention to the safety instructions provided on each label affixed to the instrument and do not alter or remove the labels. When inspecting the instrument, ensure that the safety labels have not become worn or damaged.
- The AccuPyc III sound level is <65dBA from the operator's normal position, and approximately 75dBA at 20 cm from the back of the instrument. Hearing protection is optional.
- Proper maintenance is critical to personnel safety and smooth instrument operation and performance. Instruments require regular maintenance to help promote safety, provide an optimum end test result, and to prevent costly down time. Failure to practice proper maintenance procedures can lead to unsafe conditions and shorten the life of the instrument.
- Improper handling, disposing of, or transporting potentially hazardous materials can cause serious bodily harm or damage to the instrument. Always refer to the SDS when handling hazardous materials. Safe operation and handling of the instrument, supplies, and accessories are the responsibility of the operator.



If you have an ICD or pacemaker, avoid close or prolonged contact with magnets or their magnetic fields. Keep magnets at least six inches from where your device is implanted.

INTENDED USE

The **AccuPyc** Series Pycnometers are fast, fully automatic pycnometers that provide high-speed, high-precision volume measurements and true density calculations on a wide variety of powders, solids, and slurries. After analyses are started with a few touches, data are collected, calculations are performed, and results displayed. A minimal amount of operator attention is required.



The instrument is intended to be operated by trained personnel familiar with the proper operation of the equipment recommended by the manufacturer and as well as relevant hazards involved and prevention methods. Other than what is described in this manual, all use is seen as unintended use and can cause a safety hazard.



The instrument is intended to be used as per applicable local and national regulations.

TRAINING

It is the customer's responsibility to ensure that all personnel operating or maintaining the equipment participate in training and instruction sessions. All personnel operating, inspecting, servicing, or cleaning this instrument must be properly trained in operation and machine safety before operating this instrument.

ENVIRONMENTALLY FRIENDLY USE PERIOD

Hazardous Substances Table

Part Name	Hazardous Substances					
	Lead (Pb)	Mercury (Hg)	Cadmium (Cd)	Hexavalent Chromium (Cr (VI))	Polybrominated biphenyls (PBB)	Polybrominated diphenyl ethers (PBDE)
Cover	o	o	o	o	o	o
Power Supplies	o	o	o	o	o	o
Printed Circuit Boards	o	o	o	o	o	o
Cables, Connectors & Transducers	x	o	o	o	o	o

- o Hazardous substance is below the specified limits as described in SJ/T11363-2006.
- x Hazardous substance is above the specified limits as described in SJ/T11363-2006.

The Environmentally Friendly Use Period (EFUP) for all enclosed products and their parts are per the symbol shown here unless otherwise marked. Certain parts may have a different EFUP (for example, battery modules) and are marked to reflect such. The Environmentally Friendly Use Period is valid only when the product is operated under the conditions defined in the product manual.



SYMBOLS THAT APPEAR ON THIS INSTRUMENT



When this symbol is displayed, refer to this manual for additional information.

Table of Contents

About this Manual	iv
General Safety	v
1 About the AccuPyc III	1 - 1
Instrument Components	1 - 2
System Components	1 - 5
Verification Standard	1 - 5
Sample Chamber Cap	1 - 5
Temperature Control (TEC)	1 - 6
Advanced Temperature Control (ATC)	1 - 7
Equipment Options and Upgrades	1 - 9
Peripheral Devices	1 - 10
Multivolume Insert Option	1 - 12
Configuration Options	1 - 14
Gas Requirements	1 - 15
Specifications for AccuPyc III	1 - 16
2 About the Software	2 - 1
Guided Setup	2 - 1
Touchscreen	2 - 4
Analysis	2 - 8
Records	2 - 13
Records Filtering Options	2 - 17
Settings	2 - 18
General	2 - 18
Time	2 - 20
Method	2 - 21
Chamber	2 - 27
Inserts	2 - 31
Calibration	2 - 35
Display	2 - 40

Communications	2 - 41
Help	2 - 46
Software Updates	2 - 49
Service	2 - 50
3 Maintenance and Troubleshooting	3 - 51
Safe Servicing	3 - 52
Power	3 - 53
Power Cable	3 - 54
Ethernet Cable	3 - 54
Chamber Cap	3 - 55
Chamber Cap O-Ring	3 - 55
Clean the Pycnometer	3 - 57
Decontamination of the Pycnometer	3 - 57
Block Condensation	3 - 58
Guidelines for Connecting Gases	3 - 59
Replace a Gas Cylinder	3 - 61
Regulator Pressure	3 - 63
Recover From a Power Failure	3 - 64
Power Instrument On and Off	3 - 64
Parts and Accessories	3 - 64
A Export Data	A - 1
B Volume Change with Temperature	B - 1
C Error Messages	C - 1
D MicroActive	D - 1
AccuPyc III Declaration of Conformity - EU	DoC - 1
AccuPyc III Declaration of Conformity - UK	DoC - 2

1 ABOUT THE ACCUPYC III



Gas pycnometry is recognized as one of the most reliable techniques for obtaining true, absolute, skeletal, and apparent volume and density. This technique is non-destructive as it uses the gas displacement method to measure volume. Inert gases, such as helium or nitrogen, are used as the displacement medium. Density calculations using the gas displacement method are much more accurate and reproducible than the traditional Archimedes water displacement method.

Helium is the most used gas for pycnometry due to its ideal behavior; however, there are times where other gases can be substituted for helium. Helium has the ability to permeate into pores that are closed from the surface and interacts with some organic materials and microporous carbons. The solution is to use another gas such as nitrogen, argon, or air. Larger molecules such as sulfur hexafluoride can be used to include the volume of very small pores in volume results. Care should be taken to select a gas that does not interact with the sample material.

The AccuPyc III pycnometer is a fast, fully automatic pycnometer that provides high-speed, high-precision volume measurements and true density calculations on a wide variety of powders, solids, and slurries. After analyses are started with a few touches, data are collected, calculations are performed, and results displayed. A minimal amount of operator attention is required.

INSTRUMENT COMPONENTS

FRONT/TOP COMPONENTS



The sample chamber, located on the top panel, is where the sample cup is placed for analysis. The sample chamber should remain capped except when inserting or removing a sample. When left uncapped, water vapor adsorbs on the inner surface of the chamber and the chamber temperature stability may be affected. Either condition can affect analysis results. If water vapor accumulates in the chamber, the pycnometer must be purged.



When cooling the sample block, the sample cap should be kept closed, when possible, to avoid condensation. In addition, surfaces may be hot when heating the sample block.

Front Components

Component		Description
A	Touchscreen	Provides access to all software functionality. Touchscreen on page 2 - 4
B	USB Port	Connects a keyboard or other USB peripheral including mouse, barcode reader, or USB data storage device. The port is located behind the front panel.
C	Panel	Press and release above the front logo and swing the door down. The inside of the front panel contains a storage location for verification standards.
D	Indicator Lights	<ul style="list-style-type: none"> ■ Off. Instrument is idle. ■ Blue. Analysis. ■ Orange. Waiting for user. ■ Red (flashing). Error.
E	Sample Cap	<p>Provides access to the sample chamber for loading or retrieving a cup and sample.</p> <hr/> <div style="display: flex; align-items: center;">  <p>The cap should be left fully closed so that background purges (if selected) can proceed normally without wasting helium directly out of the open sample cap. <i>For information on background purges, refer to Settings > General on page 2 - 18.</i></p> </div> <hr/>
F	Verification Standards	Spheres of known volume used to check operation of the instrument done in Settings > Chamber > Verify .

BACK COMPONENTS



Back Components

Component		Description
A	Analysis Gas Port	Connects the analysis gas. Helium is recommended.
B	Vacuum Port	Allows connection of an optional vacuum pump for sample preparation.
C	Vent Port	The exhaust port for the analysis gas.
D	Dry Air Port	Attaches a dry air or nitrogen source for preventing condensation inside the instrument at low analysis temperatures.
E	LAB NET Port	Allows connection to a network for remote operation and data storage.
F	MIC NET Port	Allows sharing of records, methods and inserts among instruments.
G	Power Connector	Connects the power source to the instrument.
H	USB Ports	Connects a keyboard or other USB peripheral including mouse, bar-code reader, USB data storage device, or Wi-Fi module.
I	Dust Filters	There are two dust filters located on the back of the AccuPyc III. These should be checked regularly to make sure they are clean. To clean the dust filter, remove the filter from the tray and use a method that is appropriate in your laboratory.

SYSTEM COMPONENTS

VERIFICATION STANDARD

- Wear latex or nitrile, powder-free gloves to prevent transfer of oil from hands.
- Do not drop the standard into the sample cup. Gently place the standard into the cup to prevent damage.
- Always return the standards to the storage location inside the front panel of the instrument.
- Standards are unit specific.

SAMPLE CHAMBER CAP

- Wear latex or nitrile, powder-free gloves to prevent transfer of oil from hands.
- Keep the sample chamber cap closed except when inserting or removing the sample cup.



When left open, the sample chamber temperature stability may be affected and/or water vapor will adsorb on the inner surface of the chamber. Either of these conditions can affect analysis results.

TEMPERATURE CONTROL (TEC)

Density measurements at specific temperatures are required for certain applications. The AccuPyc III TEC maintains an accurate temperature control during analysis without external supplies or systems.

All units use a thermoelectric cooler (TEC) for stability. ATC units allow setting the chamber temperature from 4 °C to 60 °C.



Adequate ventilation is required to ensure effective temperature control and system longevity. Ensure that the underside and back of the instrument are free of obstruction and receive sufficient air flow.



The TEC air intake may gather dust and impede performance. The intake filter should be inspected weekly and cleaned with a duster or compressed air, if necessary. If extremely dirty, wash and dry overnight, especially if in a dirty environment.

ADVANCED TEMPERATURE CONTROL (ATC)



Since temperature stabilized units always operate at 20 °C, this accessory is provided for ATC units only. The lowest analysis temperature that can be used without flowing dry gas depends on the humidity of the air in the lab.

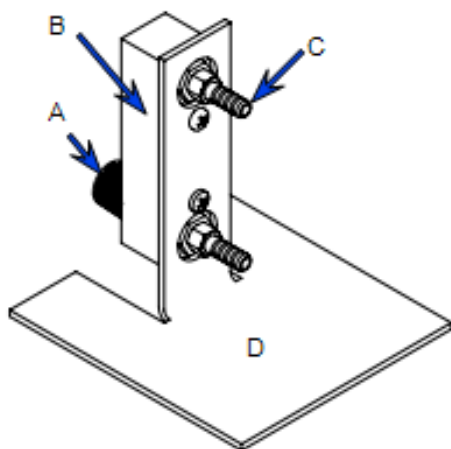

- A. Knob to adjust gas supply
- B. Rotameter
- C. Barbed male connector (2)
- D. Bracket

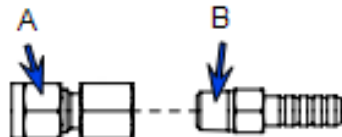

- A. Female fitting
- B. Barbed male connector

Moisture in the air can condense on exposed metal surfaces like valves and under the cap when operating the instrument at low temperature. Condensation can cause some parts to rust and can affect temperature control due to the high heat of vaporization of water.

Condensation can be prevented by flowing dry gas around the cold components. In the AccuPyc III, a dry gas source, typically dry compressed air or nitrogen, can be connected to the *Dry Air* port on the back of the instrument. The gas is directed through the area under the cap and around the valves to displace room air.

The ATC regulates the flow of dry gas. It consists of a manual flow meter and valve for establishing a flow rate of 100 to 200 sccm. The meter has a stand to keep it upright. Fittings and flexible tubing for connecting the meter to instrument are provided. The customer supplies a connection from the gas supply to a barbed fitting on the flow meter.

To attach the ATC assembly to the instrument:

1. Connect the female fitting to the *Dry Air* port on the back of the instrument.
2. Connect one end of a flexible tubing to the top barbed male connector on the rotameter assembly and the other end to the barbed male connector connected to the *Dry Air* port on the back of the instrument.
3. Connect one end of a flexible tubing to the bottom barbed male connector on the rotameter and the other end to the gas supply. Use the adjustment knob to adjust the flow of gas.

EQUIPMENT OPTIONS AND UPGRADES

MULTIVOLUME INSERTS

The Multivolume option is used to analyze smaller sized samples. Optional accessories (sold separately) include inserts, reference standards, and sample cups:

- 10 cm³ nominal cell volume. Contains 0.1 cm³, 1.0 cm³ and a 3.5 cm³ inserts.
- 100 cm³ nominal cell volume. Contains 10 cm³ and 35 cm³ inserts.

OTHER ACCESSORIES

- Foam cutting tools
- Filter caps
- FoamPyc sample prep kit
- Vacuum attachment

PERIPHERAL DEVICES

KEYBOARD

A USB keyboard can be attached to the AccuPyc III for completing entry fields. If a keyboard is connected while the software is running, it is available for immediate use. This item is optional and must be provided by the customer.

MOUSE

A USB mouse can be attached to the AccuPyc III. If the mouse is plugged in while the software is running, a restart is required in order to see the mouse cursor. If the mouse is unplugged while the software is running, the cursor still displays on screen. This item is optional and must be provided by the customer.

BARCODE SCANNER

A USB barcode scanner can be attached to the AccuPyc III. While the information scanned (typically a sample identification code) can be inserted into any field, it is commonly added to the *Description* field when performing an analysis. This item is optional and must be provided by the customer.

WI-FI

Wi-Fi is provided via a dongle that is inserted into a USB port on the AccuPyc III instrument.

SET UP

1. Insert the dongle into the applicable port.



2. On the touchscreen, tap **Settings > Communications** and select *TCP/IP*.
3. In the *Wi-Fi* field, tap and select a Wi-Fi network. If a Wi-Fi network is not shown, or a connection cannot be made, refer to [Error Messages on page C - 1](#) for resolution actions.
4. Enter the Wi-Fi password.
5. Tap **Save**.

VERIFICATION (OPTIONAL)

After setting up the Wi-Fi network, validate the Wi-Fi is operational by doing the following.

1. On the touchscreen, tap **Settings > Communications** and select *Printer*.
2. For the *Printer Type* (if Wi-Fi is not already selected), tap and select the *Wi-Fi* printer from the list.
3. Tap **Save**.
4. Tap **Records** and select a record to print.
5. Tap either **Results** or **Method**.
6. Tap **Print**. The report is sent to the printer. If the report does not print, refer to [Error Messages on page C - 1](#) for resolution actions.

MASS BALANCES

When connecting a balance to the AccuPyc III, verify the transferred output is numerical only and does not contain any text or special characters.



While other balances can connect to the AccuPyc III, verification is required to make sure the transferred output from the balance is numerical only and does not contain any text or special characters.

This item is optional and must be provided by the customer.

MULTIVOLUME INSERT OPTION

Settings > Inserts

The Multivolume Insert option provides analysis of samples using smaller-sized sample chambers.



Wear latex gloves when handling inserts and sample cups. Oils from skin may contaminate the surface and affect analysis results. Refer to [System Components on page 1 - 5](#).

Equipment	Description
AccuPyc 10 cm ³	Includes 0.1 cm ³ , 1.0 cm ³ and 3.5 cm ³ inserts with corresponding sample cups, fritted filter lids and appropriate verification standards. The 0.1 cm ³ insert can be treated as a cup for the 1.0 cm ³ insert
AccuPyc 100 cm ³	Includes 10 and 35 cm ³ inserts with corresponding sample cups and appropriate verification standards. A fritted filter lid, which prevents the escape of sample particles under rapid gas flow, is included for the 10 cm ³ insert.

An insert changes the size of the sample chamber and requires its own sample cup. All inserts are shipped with appropriate cups.

- The fritted filter caps for the 1 cm³ and 3.5 cm³ inserts fit on top of the insert.
- The cap for the 10 cm³ insert fits on the sample cup. This example shows a 10 cm³ cup and insert.

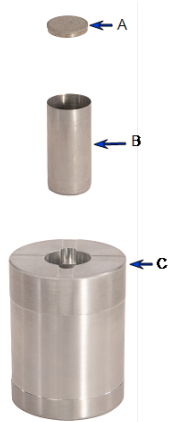

- A. Fritted filter
- B. Sample cup
- C. Insert

INSTALL AND REMOVE INSERTS AND SAMPLE CUPS

Open the chamber cap and place the insert into the sample chamber. The insert should fit snugly in the chamber. Place the appropriate sample cup into the well of the insert. The 0.1 cm³ insert can be treated as a cup for the 1.0 cm³ insert.



Do not force the insert or cup into the openings. This may damage the instrument, insert, or sample cup.

Install the fritted filter cap (if used) before closing the sample chamber. A fritted filter cap is used to constrict gas flow and is included with some inserts. The fritted filter cap for the 10 cm³ insert fits on the top of the sample cup. The fritted filter caps for the 1 and 3.5 cm³ inserts fit on the top of the insert. Refer to [Inserts on page 2 - 31](#) and [Insert on page 2 - 22](#)

CONFIGURATION OPTIONS

For best fit with a sample, the AccuPyc III is available in multiple configurations. "Best fit" means the sample nearly fills the sample chamber and, therefore, optimizes the precision of the results.



All sample chamber volumes are nominal.

- 10 cm³ sample chamber
- 100 cm³ sample chamber

TEMPERATURE CONTROLLED OPTIONS

Each chamber size is available with *Temperature Stabilization* (TS) or *Advanced Temperature Control* (ATC). Both configurations provide active temperature control for stability.

- TS units operate at 20 °C.
- ATC units can be set from 4 °C to 60 °C.



For ATC units, *Method* allows for selection of the analysis temperature. Refer to [Method on page 2 - 21](#).

GAS REQUIREMENTS

Guidelines for Connecting Gases on page 3 - 59



Improper handling, disposing of, or transporting potentially hazardous materials can cause serious bodily harm or damage to the instrument. Always refer to the SDS when handling hazardous materials. Safe operation and handling of the instrument, supplies, and accessories are the responsibility of the operator.



Toxic, corrosive, flammable, poisonous, or injurious gases should not be used with the AccuPyc.

The pycnometer uses helium, nitrogen, or other dry, inert gas (99.995% pure or better) to provide rapid, accurate analyses. It is recommended that the cylinder containing the analysis gas be fitted with a gas regulator set for 22 psig (152 kPag). The pressure input to the pycnometer should never be greater than this pressure.

SPECIFICATIONS FOR ACCUPYC III

Environment

Temperature	Stable between 10 to 35 °C (50 to 96 °F) Temperature change: up to 2 °C per hour
Humidity	10 to 80% relative (non-condensing) for laboratory temperature from 10 to 25 °C, maximum RH decreasing linearly to 50% at 35 °C.
Indoor or Outdoor Use	Indoor only (not suitable for wet locations) Altitude: 2000 m max (6500 ft) Pollution degree of the intended environment: 2 For best performance, the instrument will be installed in a dust-free, vibration-free environment, away from exposure to direct sunlight and direct air drafts.
Operating Pressure	152 kPa (22 psi) max
Degree of Ingress Protection	IPX0

Physical

Height	20.5 cm (8.1 in.)
Width	26.5 cm (10.4 in.)
Depth	43.0 cm (16.9 in.)
Weight	11.5 kg (25.3 lbs.)

Electrical

Voltage	100-240 VAC (±10%)	
Power	280 W	
Frequency	50-60 Hz	
External Power Adapter	Manufacturer:	Mean Well
	Part Number	GET280A24-C6P

Gases

Research grade helium is recommended. If unavailable, use helium with a dew point of $-67\text{ }^{\circ}\text{C}$ ($-88\text{ }^{\circ}\text{F}$) or lower.

Sample Cups

10 cm ³ chamber	1.85 cm ID × 3.95 cm D (0.72 in. ID × 1.55 in. D)
100 cm ³ chamber	4.62 cm ID × 6.18 cm D (1.82 in. ID × 2.43 in. D)

Analysis

Precision	Reproducibility is typically to within $\pm 0.01\%$ of the nominal full-scale sample chamber volume. Reproducibility is guaranteed to within 0.015% of the nominal full-scale volume on clean, dry, thermally equilibrated samples using helium.
Accuracy	Accurate to within 0.02% of (nominal full-scale sample chamber volume + measured sample volume).
Gas Consumption	Approximately 1 cm ³ STP times the nominal cell volume per analysis cycle.

Temperature Control

Range	4 to 60 °C for ATC units
Stability	$\pm 0.025\text{ }^{\circ}\text{C}$

Due to continuous improvements, specifications are subject to change without notice.

**This page
intentionally
left blank**

2 ABOUT THE SOFTWARE

Analysis provides the measurement of sample volume, from which density can be derived automatically once the sample mass is entered. The unit comes preprogrammed with default conditions and ready to perform analyses. It can be reprogrammed to meet specific needs. Analyses can be modified (*refer to [Method on page 2 - 21](#)*). Modifying these parameters allows control of the primary portions of the analysis: purge and run.

GUIDED SETUP

Use the information below to set up the AccuPyc III at first usage or after a factory reset has been completed.

CONNECT THE REGULATOR AND GAS LINE

1. Place gas cylinder within 6 feet (2 meters) of the instrument.
2. Connect the proper regulator for the selected gas cylinder:
 - CGA 580: Nitrogen, helium, argon
 - CGA 320: Carbon dioxide
 - CGA 590: Air, SF6
3. Connect the provided 1/8 in. copper tubing from the regulator into the analysis gas inlet located on the rear of the instrument.
4. Open and close the valve on the gas cylinder.
5. Increase the pressure on the regulator to 22 psig (152 kPag), unless another operating pressure will be used.
6. Use a soapy solution to verify that the connections from the gas cylinder to the instrument are leak free.

OPTIONAL: CONNECT VACUUM PUMP

A vacuum pump can optionally be connected to the AccuPyc III. An accessory kit is available to make the proper connections.

OPTIONAL: CONNECT DRY AIR

- Dry air can be connected to the AccuPyc III and is recommended for analyses at lower temperatures where condensation might happen.
- If the analysis temperature is below room temperature and the laboratory is humid, it's a good idea to connect dry air.
- Dry compressed air or nitrogen is connected using a 1/8 inch nut.
- Flow should be set to approximately 2 psig (14 kPag).

OPTIONAL: CONNECT USB DEVICE

There are USB ports located on both the front and back of the AccuPyc III. Mouse, keyboards, analytical balance, Wi-Fi dongle, barcode scanner, and USB drives can be connected. If a mouse is connected, the power must be cycled before it can be used.

OPTIONAL: CONNECT LAB NET OR MIC NET

There are two Ethernet connections on the back of the AccuPyc III.

- The **MIC NET** allows the AccuPyc III to be connected to other AccuPyc IIIs as well as legacy AccuPyc II instruments. Reports from the connected legacy instruments can be displayed in the AccuPyc III Records screen.
- The **LAB NET** connects a unit to a network. If a computer is connected to the same subnet as the instrument, the unit can be controlled through a browser. Data can be exported from the instrument and viewed within the MicroActive software.

ENABLE WI-FI

To enable Wi-Fi capabilities, a dongle is required and can be plugged into one of the USB ports on the back of the instrument.

1. On the touchscreen, tap **Settings > Communications > TCP/IP**.
2. In the *Wi-Fi* field, tap and make a selection.

CONNECT TO BROWSER

The AccuPyc III can be controlled through a browser. Chrome is recommended.

1. Connect an Ethernet cord to the LAB NET port on the back of the instrument. The unit will need to be connected to a network via Ethernet in which a DHCP server can assign an IP address to the instrument. A DHCP server located on your network will automatically assign an IP address to the AccuPyc III.
2. On the touchscreen, tap **Settings > Communications**.
3. Note the IP address shown in the *LAB NET* field.
4. Type this address into the browser.

CONNECT A PRINTER

Printers can be accessed either through Wi-Fi or Network under the Printer type.

On the touchscreen, tap **Settings > Communications > Printer**.

- If **Wi-Fi** is selected, the Wi-Fi printer can be selected here. The AccuPyc III must be connected to a Wi-Fi network.
- If **Network** is selected, the following information will have to be entered: User, Password, Domain, Workgroup, and Printer Name.

CONNECT LEGACY 1345 INSTRUMENTS

1. Connect the AccuPyc III to legacy instruments using Ethernet connections on the MIC NET port.
2. On the touchscreen, tap **Settings > Communications > Legacy**.
3. Press the plus + key to add a new instrument.
4. Enter the IP Address of the 1345.



Ensure the IP address entered matches the IP address defined in the 1345. The IP address must be within the MIC NET Subnet. For example, if the MIC NET Subnet is '10.151', the first two octets of the 1345 IP address must be '10.151.X.X', a subnet of 255.255.0.0, and not match the 1350s.

OPTIONAL: CONNECT BALANCE

Analytical balances can be connected to the AccuPyc III to transfer mass directly from the balance to the instrument. Balances can be connected via USB. The balances tested and known to work are Sartorius BCE224I-1S and Mettler Toledo ME204T/00.

1. On the touchscreen, tap **Home**.
2. Tap the *Mass* entry field on the Analysis screen.
3. Press the transfer button located on the balance while weighing the sample. The mass will be transferred and the analysis ready to start.

TOUCHSCREEN

The AccuPyc III touchscreen is located on the front of the instrument, and provides access to all functions and operations. In addition to the touchscreen, the software can be accessed via a web browser by entering the IP address of the instrument in the URL field.

ICONS

The following icons are always displayed on the left side of the main screen:



Analysis. Start and monitor analysis. See [Analysis on page 2 - 8](#).



Records. Displays results of completed analyses. See [Records on page 2 - 13](#).



Settings. Configures analysis parameters and instrument options. See [Settings on page 2 - 18](#).



Help. Includes several types of information:

- System details such as Serial Number, Configuration, Last Analysis, Warranty Expiration, Next Service Due, and Software Version.
- Tips, Practices and Videos.
- Log of selected activities.

BUTTONS

Internal screens (those displayed when an icon is selected) may contain any of the following buttons:



Adds a new item for the selected function.



OK to acknowledge a message.



Termination. When this button is displayed and selected, termination of the current operation occurs.



Saves the information on the screen or acknowledges the information has been viewed (for screens showing results).



Saves when editing a Method and the **Back** button is selected.



Deletes the currently displayed information and closes the screen.



Next moves ahead to the next screen.



Prints the currently displayed analysis results. If a printer is not configured, the Printer icon is not shown. To verify a printer is configured, or to set up a new printer, see **Settings > Communications > [Printer on page 2 - 43](#)**.



Previous returns to the previous screen.



Exports the currently displayed analysis results. When exporting a document, a location must be configured through **Settings > Communications > [Export on page 2 - 42](#)**.



Edits the information on the current screen.

KEYBOARD AND NUMERIC PAD

The appropriate screen is presented based upon the function selected.



An external keyboard and mouse can be connected to the instrument using the USB port.

Text fields display the keyboard. Different languages show the corresponding keyboard.

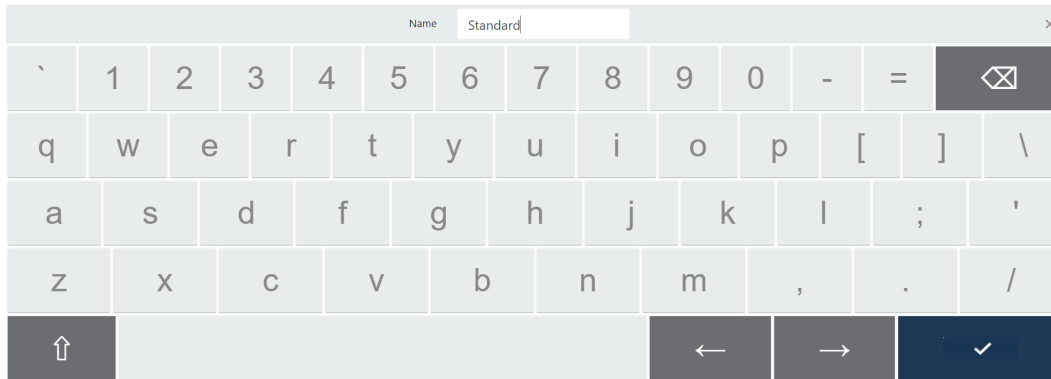

Keyboard Functions

Button	Description
Back Arrow	Moves left and erases a character or number.
Up Arrow	Switches the display between upper and lower case letters.
Left/Right Arrows	Moves left or right one character at a time but does not erase the letter, number, or symbol.
Checkmark	Confirms the information entered and closes the keyboard.

Number fields display the numeric pad.

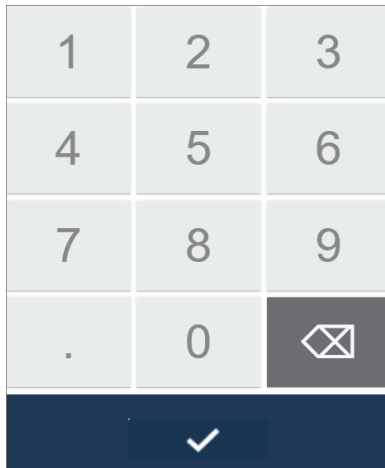

Numeric Pad

Button	Description
Back Arrow	Moves left and erases the last number or symbol.
Checkmark	Confirms the information entered and closes the numeric pad.

SLIDER

Use the slider to enable or disable an option.



ANALYSIS

Use to perform an analysis. When analyzing a sample, ensure the insert and cup in the selected method match the insert and cup being used.

Some samples require external preparation prior to placing in the sample chamber. This can remove volatiles from the sample that would otherwise damage internal components or impact the pressure readings. When moisture is present on a sample, the vapor pressure impacts the pressure readings.

Maximum accuracy is obtained when the sample chamber is nearly filled with sample. The minimum suggested sample quantity is 10% of the available volume within the sample chamber. If a small sample quantity is available, inserts can be used to further reduce the available sample chamber volume.

1. Tap **Analysis**.



Settings > [Display on page 2 - 40](#) determines if the *Method*, *Description* and *Operator* fields are shown.

2. Select a *Method* from the list. *Standard* is the default unless another method has been configured and enabled as the default. To add a new method, refer to **Settings** > [Method on page 2 - 21](#).
3. Enter a *Description* to display when results are shown on screen, printed, or exported.
4. Enter text to display that identifies the *Operator*. This field is only available if the Operator function has been enabled under **Settings** > [Display on page 2 - 40](#).
5. Enter the sample *Mass*.

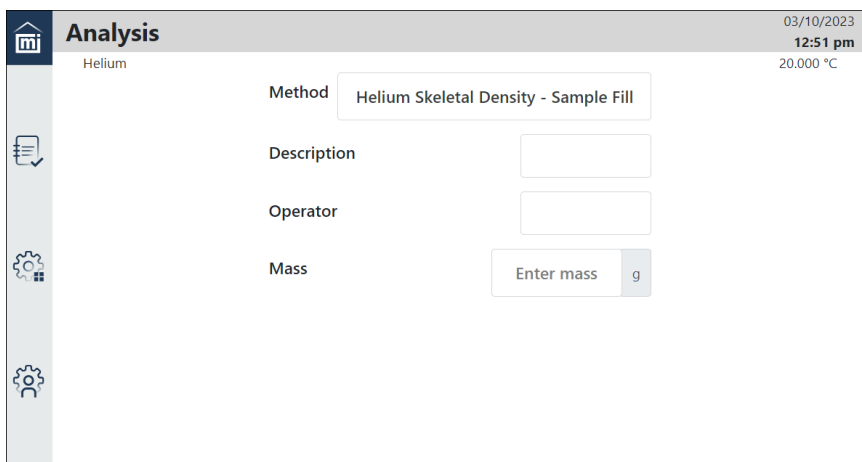

Analysis		03/10/2023 12:51 pm 20.000 °C
Helium	Method	Helium Skeletal Density - Sample Fill
	Description	<input type="text"/>
	Operator	<input type="text"/>
	Mass	<input type="text" value="Enter mass"/> g

6. Tap **Next**.

7. Review the sample instructions.

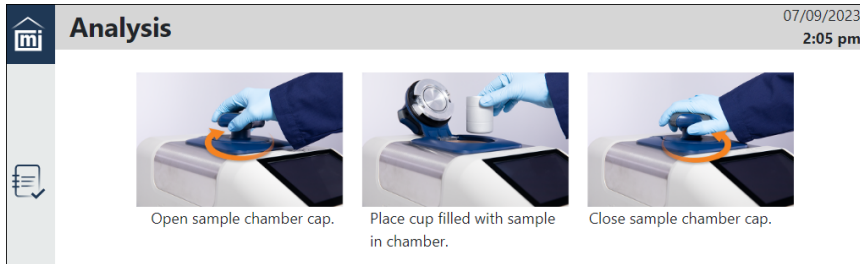

8. Tap **Next**. The analysis begins. To stop the analysis at any point, tap **Cancel**.

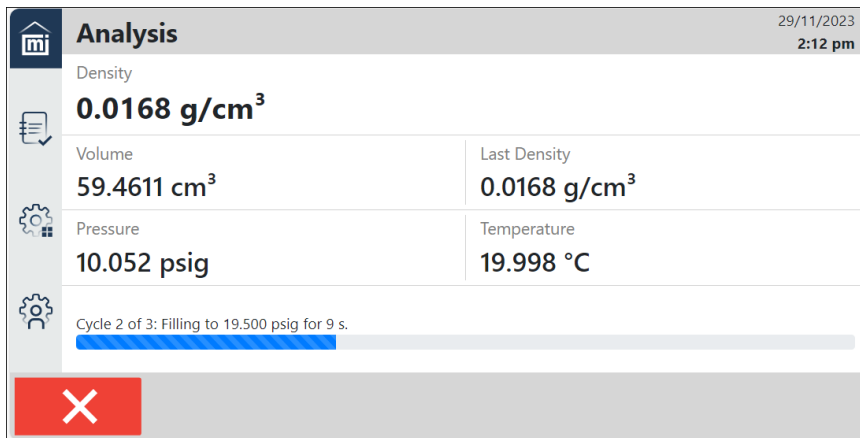

9. When the analysis is complete, the results screen displays.

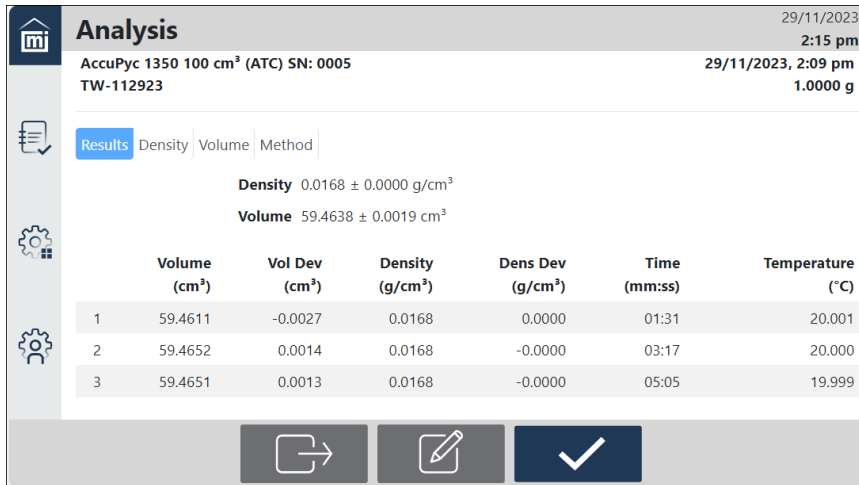

10. Tap on a tab to view the results for *Density*, *Volume*, or *Method*.

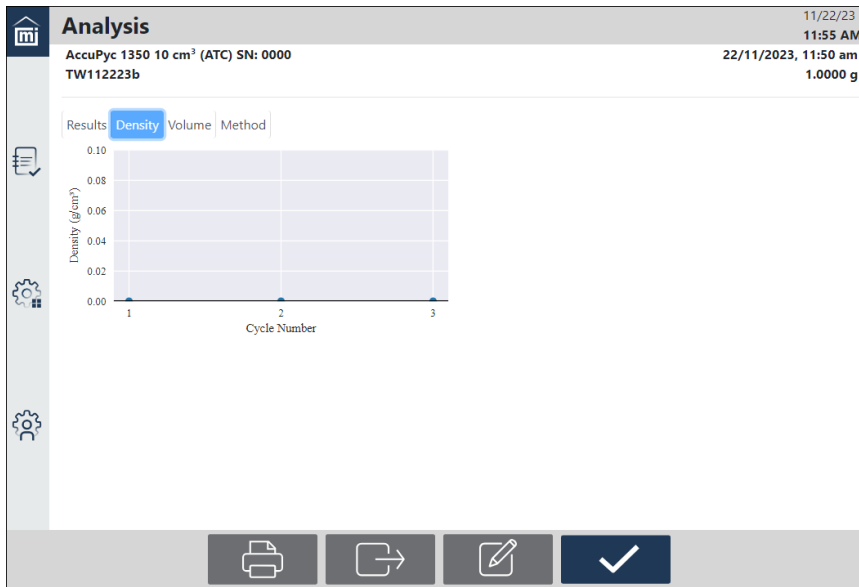

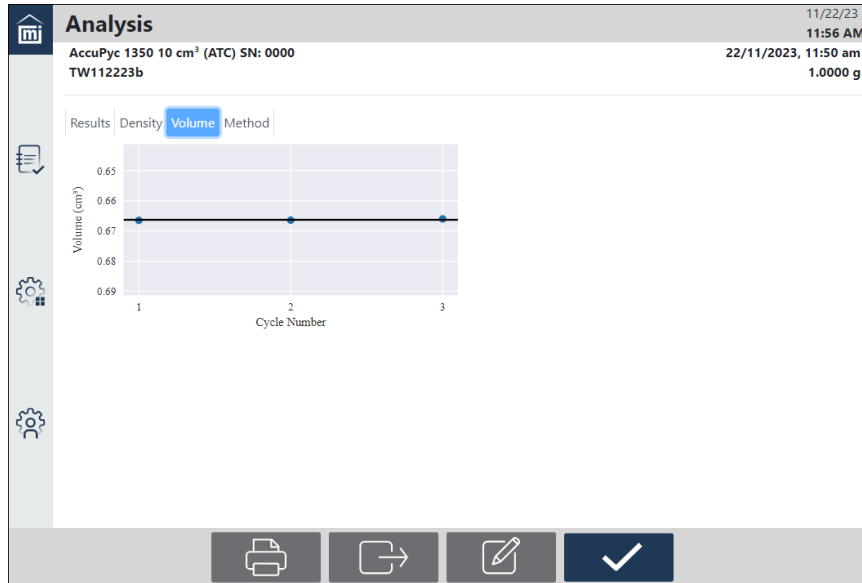

Operator: CKB
 Name: Skeletal Density - Sample Fill
 Gas: Helium
 Temperature: 20.000 °C
 Cup: Cup
 Fill Direction: Sample Chamber
 Pre-Purge While Changing Temperature: Yes
 Use Vacuum Preparation: No
 Purges: 0
 Purge Fill Pressure: 1.000 psig
 Cycles: 3
 Cycle Fill Pressure: 19.500 psig
 Pressure Stabilization: Time
 Interval: 10 s

11. Tap **Print** to print the data on the configured printer.
12. Tap **Export** to send the results to a USB drive or save to a network drive as a certain file type (PDF, XLS, TXT, or RAW).

13. Tap **Edit** to change the *Mass*, *Description*, *Operator*, *Cup*, or *Insert*. These changes are reflected on the results screen.

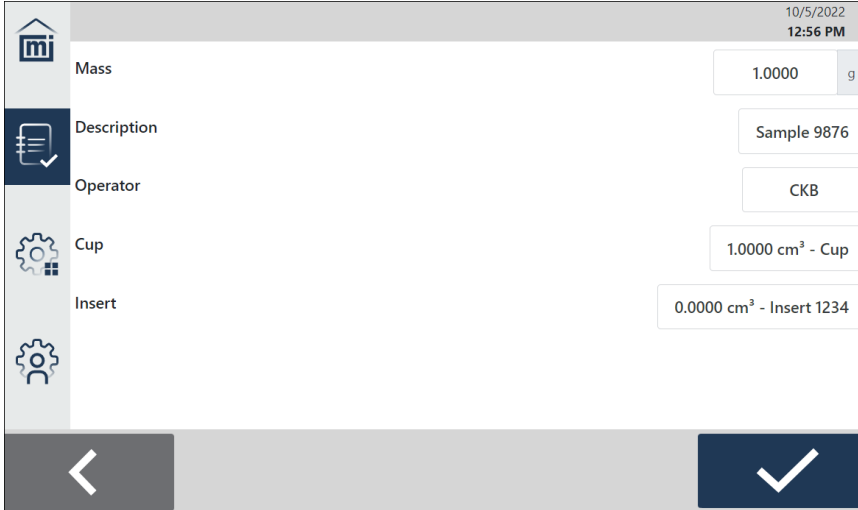

10/5/2022
12:56 PM

Mass	1.0000 g
Description	Sample 9876
Operator	CKB
Cup	1.0000 cm ³ - Cup
Insert	0.0000 cm ³ - Insert 1234

14. If changes are made, tap **Save**. If no changes are made, tap **Back** to return to the results screen.

RECORDS

Use to view the results of the analysis.



If no results are shown on the Records screen for a specific analysis, adjust the filters and re-open the Records screen (refer to [Records Filtering Options on page 2 - 17](#)).

1. On the main screen, tap **Records**. The list of analysis results displays.
2. To view the details, click on a record.

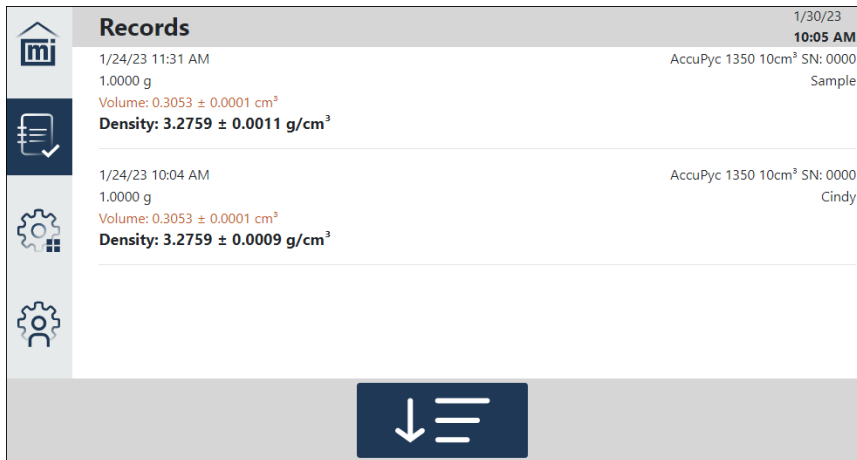

3. Tap an analysis record. A table of measurements for that record is displayed.

Records 11/21/23
9:10 AM
AccuPyc 1350 10 cm³ (ATC) SN: 1015
Cal Balls 20@60 RF 11/21/23, 7:36 AM
100.0000 g

Results Density Volume Method

Density 15.6864 ± 0.0004 g/cm³
Volume 6.3750 ± 0.0001 cm³

	Volume (cm ³)	Vol Dev (cm ³)	Density (g/cm ³)	Dens Dev (g/cm ³)	Time (mm:ss)	Temperature (°C)
1	6.3748	-0.0002	15.6869	0.0005	13:18	60.014
2	6.3751	0.0001	15.6860	-0.0004	14:31	60.014
3	6.3749	-0.0001	15.6865	0.0002	15:42	60.015
4	6.3750	0.0001	15.6862	-0.0002	16:53	60.016
5	6.3749	-0.0000	15.6864	0.0001	18:03	60.014
6	6.3751	0.0001	15.6861	-0.0002	19:16	60.005
7	6.3748	-0.0002	15.6868	0.0004	20:25	60.007
8	6.3751	0.0001	15.6860	-0.0004	21:36	60.002
9	6.3750	-0.0000	15.6864	0.0000	22:45	60.005
10	6.3751	0.0001	15.6860	-0.0003	23:52	60.006

4. Tap a tab to view the data for *Density*, *Volume*, or *Method*.



If an analysis is run with only one cycle, the **Density** and **Volume** tabs are not displayed.

Density

Records 7/6/23
9:15 AM
AccuPyc 1350 10 cm³ (ATC) SN: 0000
Test 6/21/23, 9:28 AM
1.0000 g

Results Density Volume Method

Density (g/cm³)

Cycle Number

Records

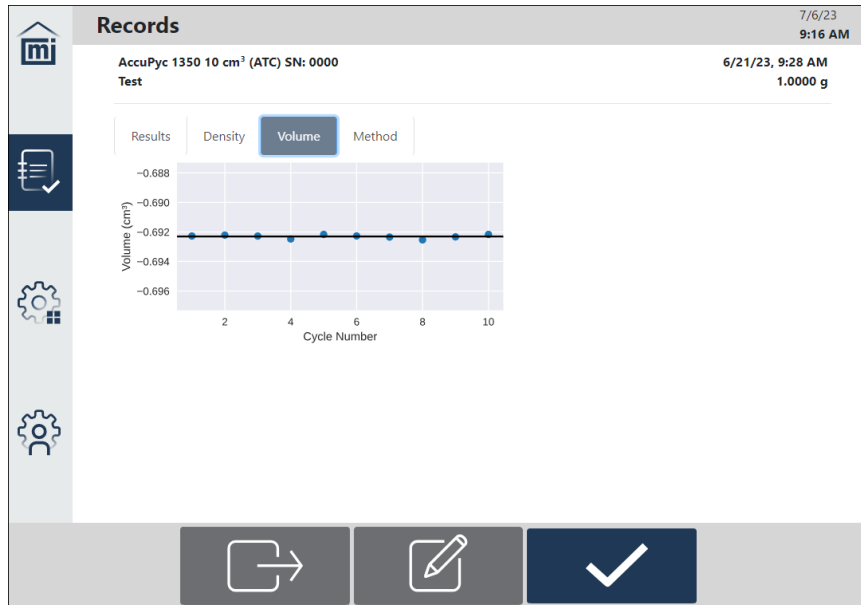

Method

Operator: CKB
 Name: Helium Skeletal Density - Sample Fill
 Gas: Helium
 Temperature: 20.000 °C
 Cup: Cup
 Fill Direction: Sample Chamber
 Pre-Purge While Changing Temperature: Yes
 Use Vacuum Preparation: No
 Purges: 10
 Purge Fill Pressure: 19.500 psig
 Cycles: 10
 Cycle Fill Pressure: 19.500 psig
 Pressure Stabilization: Rate
 Equilibration Rate: 0.0050 psig/min
 Technique: Gas Pycnometry
 Use Run Precision: No
 Sample Chamber Volume: 3.3846 cm³
 Expansion Chamber Volume: 3.0749 cm³



The **Cycles** and **Cycle Fill Pressure** data is *not* shown when the selected **Technique** is *Compressibility Test* or *Cell Fracture Test*.

5. Tap **Print** to send the selected results to the configured printer.
6. Tap **Send** to export the selected results to either a USB drive or save to a network drive as a certain file type (PDF, XLS, TXT, or RAW).



When exporting a document, a location must be configured through **Settings > Communications > [Export on page 2 - 42](#)**.

7. To modify the *Mass*, *Description*, *Operator* (if shown), *Cup*, or *Insert*, tap **Edit**, make the applicable changes, then tap **Save**.
8. When all the applicable actions (Print, Send or Edit) are complete, tap **Save**.

RECORDS FILTERING OPTIONS

Use to specify the filtering options for record results.

1. On the main screen, tap **Records**.
2. Tap the down arrow.

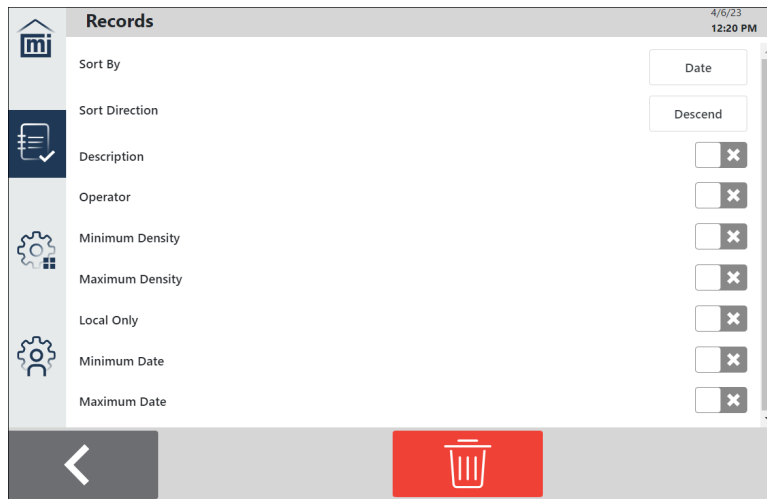

Filtering Options

Field	Description
Sort By	Select the sort criterion, either <i>Date</i> or <i>Density</i> .
Sort Direction	Select the sort direction, either <i>Descend</i> or <i>Ascend</i> .
Description	Displays only records with descriptions that match the entered text.
Operator	Displays only records with operators that match the entered text. This option is shown when Display on page 2 - 40 > Operator is selected.
Minimum/Maximum Density	When selected, enter the minimum and maximum density in the listed units to include in the report.
Local Only	When selected, displays records for the local instrument only, not legacy instruments or other AccuPyc IIIs that may be attached.
Minimum/Maximum Date	Select the date range to include in the report. When selected, enter the minimum or maximum start date and time. By default, the current date and time are selected.

SETTINGS

GENERAL

Settings > General

Use to set general instrument parameters.

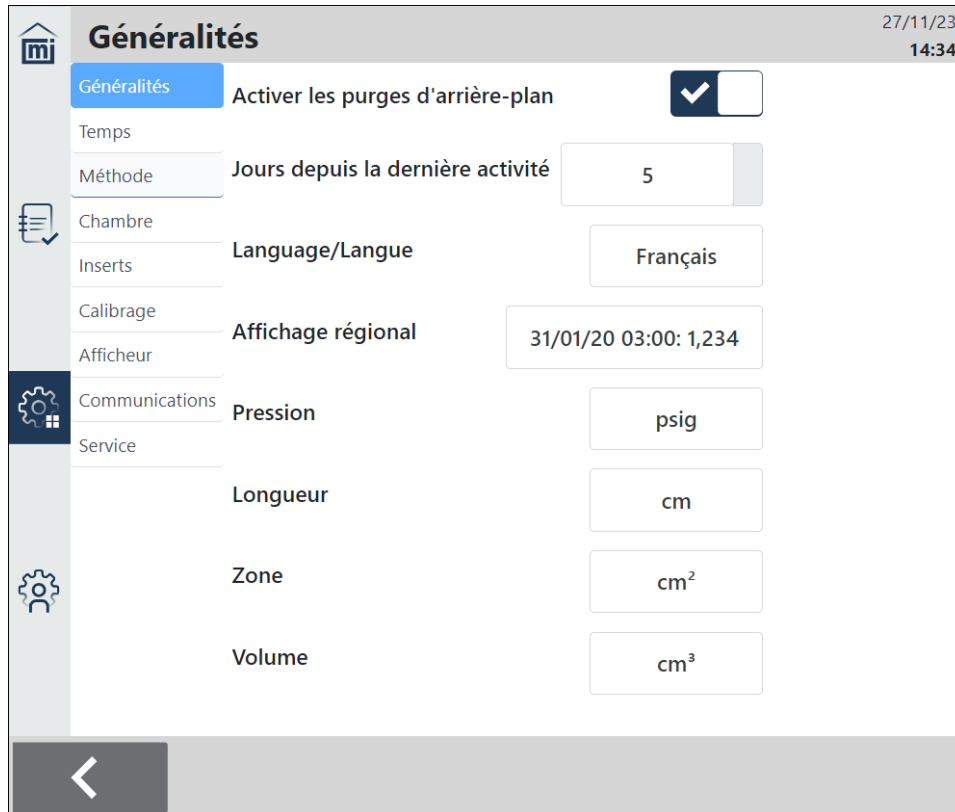

General Settings

Selections	Description
Enable Background Purges	Enables/disables purges when instrument is idle. <i>Refer to Background Purges, below.</i>
Days Since Last Activity	Sets the number of days of inactivity that then triggers the background purges. <i>Refer to Background Purges, below.</i>
Language	Specifies the language to use for selected functions in the touch-screen and report results.
Regional Display	Specifies the date and time format, and the decimal separator for numbers.

General Settings (continued)

Selections	Description
Pressure	Specifies the units (psig or kPag).
Length	Specifies the units (cm or in).
Area	Specifies the units (cm ² or in ²).
Volume	Specifies the units (cm ³ or in ³).

Background Purges

These are a set of 10 standard purges, which fill to 5.0 psig (34.5 kPag) before venting. This is the same type of purge that runs when a fill-reference analysis is started.

The purge runs automatically at 3:00 AM local time (based on the system time zone setting) each day, after the designated number of days of inactivity. When *Enable Background Purges* is selected, the *Days Since Last Activity* field displays in which the number of days to wait after the last operation can be specified (operations include analyses, volume calibrations and chamber verifications). The instrument is considered "active" when these types of actions take place. The days after inactivity begins once the instrument has gone back to "idle" status.



An analysis cannot be started while background purges are running, although other activities can take place. The background purge can be canceled (see below).



If the instrument is left idle with the sample cap open, the background purges will attempt to fill to a pressure for five minutes and then cancel with an error.

Cancel Ongoing Background Purges

1. When a background purge is running, start an analysis or chamber verification. A message displays, indicating the purge is running.
2. Tap the text.
3. At the prompt, *Cancel background purges?*, tap **Yes** to cancel the purges. A confirmation message displays. Once the confirmation closes, a green button displays and the operation can be started.
4. Tap **Next** to start the operation.

TIME

Settings > Time

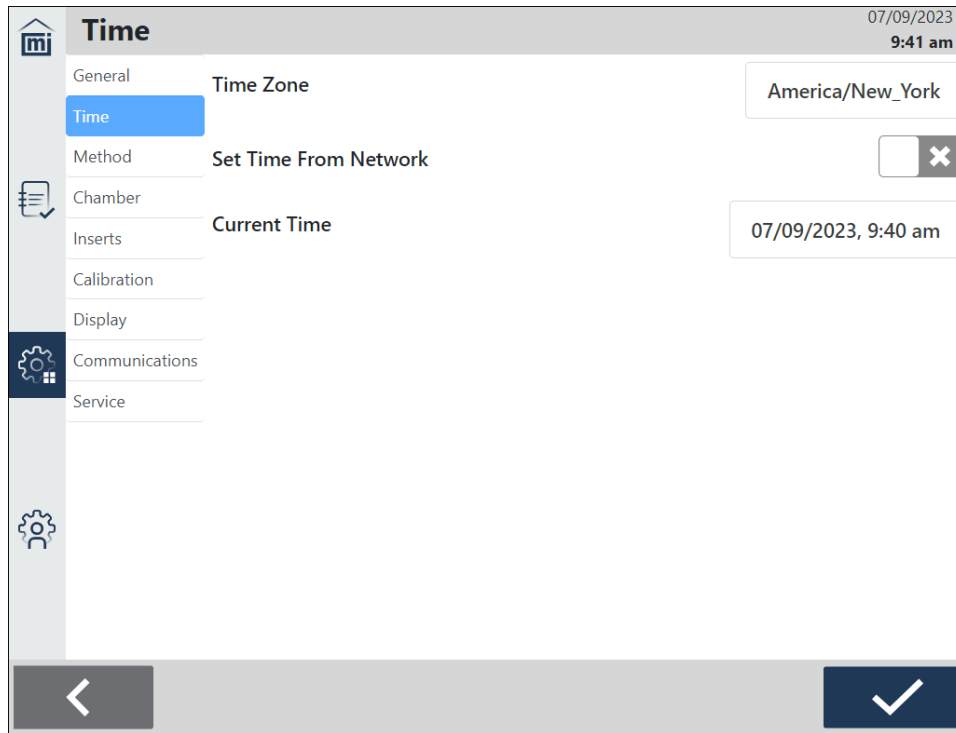

Time Settings

Field	Description
Time Zone	Displays the selected time zone. Select a new time zone.
Set Time From Network	When selected, uses the time on the system network as the default time. When unselected, displays the <i>Current Time</i> field.
Current Time	Displays only when <i>Set Time From Network</i> is disabled. Enter the current date and time. Tap Save .

METHOD

Settings > Method

[FoamPyc on page 2 - 26](#)

Methods define the parameters for each type of sample commonly analyzed, so that only a single selection is required for each new analysis record created. The default method can be edited like other methods.



Only one method can be selected as the default.

Tap **Settings > Method**.

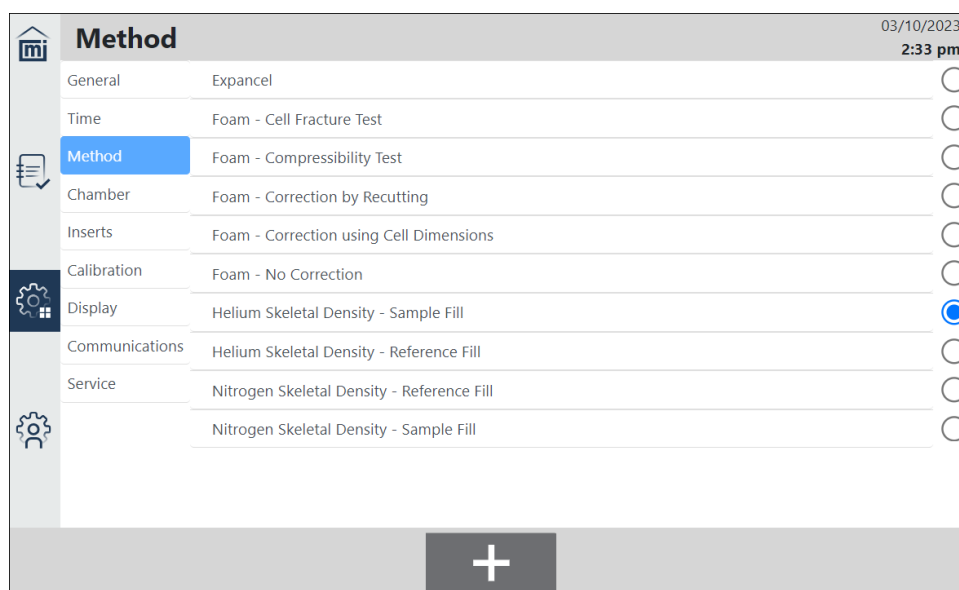

To set an existing method as the default, tap the radio button next to that method. The selection is automatically saved. This becomes the default displayed when selecting a method prior to performing an analysis.

To view the details for a standard, tap on the standard name.

To add a new method:

1. Tap **Plus**.
2. Enter the applicable details, referring to the table below.
3. When done, tap **Save**.

To delete an existing method, tap on the method, then tap **Delete**.

Method

03/10/2023
12:46 pm

General Name

Time

Method Share on MIC NET X

Chamber

Inserts Temperature °C

Calibration

Display Insert

Communications Cup

Service Fill Direction



Pre-Purge While Changing Temperature

<
🗑️

Method

Selections	Description
Name	Enter a name for the method.
Share on MIC NET	Enable to share methods between instruments connected together through the MIC NET. The instrument with the method having the latest modification will be shared.
Temperature	Specify the analysis temperature from 4 °C to 60 °C. This field is not displayed if the unit is configured as TS.
Insert	Select an insert or dashes if no insert will be used. Inserts are created under Settings > Inserts on page 2 - 31 .
Cup	Select the cup into which the sample is placed. Cups are created under Settings > Inserts on page 2 - 31 .
Fill Direction	<p>Specifies the pathway the gas is taking to enter the instrument.</p> <ul style="list-style-type: none"> ■ Select <i>Sample Chamber</i> to determine sample volume by filling the sample chamber and expanding into the internal reference chamber. The contents of the sample chamber are pressurized to the fill pressure specified in the method. Generally, the best results are obtained when the sample is exposed at a higher fill pressure. A filtered cap may be required for samples that fluidize under the entered fill pressure. ■ Select <i>Reference Chamber</i> to fill the reference chamber and expand into the sample chamber. The contents of the sample chamber are pressurized to a lower expansion pressure than the fill pressure specified in the method. This can be useful when working with powders to prevent them from fluidizing and potentially

Method (continued)

Selections	Description
	<p>contaminating the instrument outside of the sample chamber. This also limits sample compressibility. This is also useful for samples that may compress under higher pressures by exposing the sample to lower pressures, while using a higher fill pressure.</p>
<p>Pre-Purge While Changing Temperature</p>	<p>When selected, the instrument will do a purge every two minutes at the start of analysis.</p> <hr/> <div style="display: flex; align-items: flex-start;">  <div> <p>These purges only happen before the temperature is stabilized. If the temperature is already stable, there will not be any pre-purges.</p> <p>The pre-purges are not the same as the purges done at the start of analysis after temperature stabilizes. For example, if a value of 6 is selected in the Method "Purges" field, as many pre-purges as needed (assuming pre-purges are selected) are done. Then, after the temperature has stabilized, the instrument will do exactly 6 purges, and start the usual analysis cycles.</p> </div> </div> <hr/>
<p>Purges</p>	<p>Enter the number of purges or vacuum prep cycles to be performed.</p> <p>Purging fills the first chamber to the purge fill pressure and vents the gas. A purge number should be selected in which the results are consistent.</p> <p>Purging cleans the chambers before an analysis begins. The greater the number of purges or vacuum prep cycles, the cleaner the sample will be when analyzed.</p> <hr/> <div style="display: flex; align-items: flex-start;">  <div> <p>If one or more purges are entered, and the analysis <i>Fill Direction</i> is <i>Sample Chamber</i>, and <i>Use Vacuum Preparation</i> is not selected, the instrument will perform four additional purges, which purge only the reference chamber before performing the standard user-selected purges.</p> </div> </div> <hr/>

Method (continued)

Selections	Description
Use Vacuum Preparation	<p>A vacuum preparation will evacuate the sample chamber, pressurize to roughly atmospheric pressure, and then evacuate again. Using a vacuum system can help remove contaminants from samples that purging might not be able to.</p> <p>When selected, vacuum preparation cycles are performed instead of purges when analysis starts. The number of vac prep cycles is equal to the value in the <i>Purges</i> field. For example, if five purges are selected, and <i>Use Vacuum Preparation</i> is selected, five vacuum preparation cycles are run.</p> <hr/> <div style="display: flex; align-items: center;">  <p>A vacuum pump must be attached and powered on before running an analysis with a method that uses vacuum preparation.</p> </div>
Purge Fill Pressure	<p>Enter the fill pressure. For most applications, the default of 19.500 psig (134.45 kPag) is adequate. Typically, the greater the fill pressure, the easier it is to measure the volume precisely. However, a lower pressure may be required for some samples to obtain results that do not impact volume or density results.</p>
Cycles	<p>Enter the number of cycles to be performed. A cycle is a series of instrument operations, which produce a single volume measurement.</p>
Cycle Fill Pressure	<p>Enter the fill pressure. For most applications, the default of 19.500 psig (134.45 kPag) is adequate.</p>
Pressure Stabilization	<p>The instrument obtains density from the volume calculated from measuring pressure differences. Allowing the pressure to stabilize before moving on is a crucial step in achieving precise and repeatable results.</p> <p>Specify if equilibrate should be by Time (wait the specified number of seconds as set in the <i>Interval</i> field) or by Rate (wait until the pressure rate of change is less than the specified rate as set in the <i>Equilibration Rate</i> field).</p> <p>If equilibrate by <i>Time</i> is selected, the instrument will only equilibrate by time for elevated pressures. Equilibration at atmospheric pressure is always by rate. A fixed time interval moves on to the next step when the specified time has been reached.</p>
Equilibration Rate	<p>Enter the rate. The pressure measurement will end when the entered rate is obtained. A high rate will produce faster results, but with lower precision. The lowest rates may cause errors when some materials (such as those with appreciable vapor pressures or organics) are</p>

Method (continued)

Selections	Description
	<p>analyzed.</p> <hr/>  <p>If a sample is not in thermal equilibrium with the sample chamber, then the volume and density will drift. The instrument waits for temperatures to stabilize before proceeding with the analysis.</p> <p>An additional waiting period might be required depending on the sample and analysis temperatures. When in doubt, samples can be left within the chamber for up to 30 minutes before beginning an analysis to ensure the sample is in thermal equilibrium with the chamber.</p> <hr/>
Use Run Precision	<p>Allows early termination of the analysis when certain criteria are met.</p> <ul style="list-style-type: none"> ▪ Yes. The analysis terminates after five consecutive cycles are within the specified tolerance. Always request a large number (50 to 99) of runs, or when the specified number of cycles has been performed. Specifying a large number of cycles helps ensure that run precision tolerance is met. ▪ No. Run Precision is not used, and a fixed number of cycles is always used.
Technique	<p>Select <i>Gas Pycnometry</i> for standard density analysis or one of the FoamPyc on the next page methods. FoamPyc methods display additional fields specific to that technique.</p>

FoamPyc

FoamPyc capability is used for measuring open and closed cell foam materials and is included in both standard and temperature-controlled pycnometers. Five different techniques are available for analyses on materials such as polystyrene, urethane, and rubber foams.

- **Correction using cell dimensions.** Measures the closed cell fraction and corrects for the cells that were damaged while cutting the sample to the necessary size and shape. This is accomplished by using either the average cell diameter or the cell chord length (as defined in ASTM method D-6226) and the measurements of the sample to determine the volume of the cut cells. This volume is deducted from the total volume of the open cells measured by the pycnometer.
- **Correction by recutting sample.** Corrects for the cut cells by using two separate measurements. For the second measurement, the sample is recut to double the amount of cut surface. The observed difference in cut open cell volume is applied as a correction to the initial measured volume. This method offers the distinct advantage that no assumptions are needed about the relative amounts of open and closed cells.
- **No correction.** Does not correct for cut cells. It is used for materials with predominantly open cells where good accuracy can be achieved without correction. The accuracy level deteriorates as the percentage of closed cells increases.
- **Compressibility test.** The fill pressure is increased incrementally over the sample with each repeat of the P1, P2 cycle (where P1 is the initial pressure to which the sample is charged, and P2 the final pressure after expansion). The apparent variation of the measured sample volume with the average pressure is determined. This test is an approximate indication. It is not intended to be an exact measure of volume compressibility. If you want to see whether compressibility is reversible for your sample, use sample fill direction. If not, reference fill direction is recommended.
- **Cell fracture test.** A perfectly rigid foam is assumed. First, a P1, P2 cycle is performed at the lower of two specified P1 pressures, and the results stored. A second cycle is performed at a higher specified value of P1, then a third cycle identical to the first cycle is performed. The difference between the volume of the sample on the first measurement and on the third measurement is reported as the volume of fractured cells. It is assumed that cells fracture by exposure to the highest pressure (second cycle) so that when the third measurement is made, the measured sample volume has decreased from the first cycle by the amount of the closed cell volume which was fractured.

The 100 cm³ AccuPyc III has been designed and tested to follow the procedure in ASTM Method D-6226 for FoamPyc analyses. The 10 cm³ unit can be used for some types of foam materials; however, analyses on these AccuPycs will not conform to the ASTM method.

CHAMBER

Settings > Chamber

Used to verify proper calibration of the instrument (including when the last verification ran and the verification history) and run supplemental instrument operations.

The data collected for *Last* and *History* can be printed or exported.

VERIFY



This process can take several hours. During the process, a prompt displays that indicates to insert the calibration standard. Tap **Next** to continue the process.

1. If changes are required to the information already displayed, tap in the *Volume Standard* or *Fill Pressure* fields and enter the applicable values. Nominal cell volume is either 10 cm³ or 100 cm³, depending on the AccuPyc III size in use.

The screenshot shows the 'Chamber: Verify' screen with the following details:

- Header:** Chamber: Verify, 03/10/2023, 12:43 pm
- Navigation:** General, Verify (selected), Operations, Last, History
- Time:** Helium, 20.000 °C
- Method:** Volume Standard, 1.0000 cm³ - Reference Ball
- Chamber:** Fill Pressure, 19.500 psig
- Left Menu:** Chamber (selected), Inserts, Calibration, Display, Communications, Service
- Bottom:** A green arrow button pointing right.

2. Place the selected volume standard in the sample chamber.
3. Tap **Next**. The verification process takes place. The measured volume should be within tolerance of the volume standard. The tolerance is given as:

$$\text{Tolerance} = (\text{nominal cell volume} * 0.02\%) + (\text{standard volume} * 0.02\%)$$
4. Once completed, the other tabs on this screen update.
5. To stop the verification, tap **Cancel**.

OPERATIONS

Runs other instrument operations that are not an analysis or calibration.

These functions should be run in the following order:

1. Perform a **Leak Test** after connecting the gas line to the regulator and the instrument.
2. **Set the regulator pressure** until the low pressure gauge reaches 22 psig (152 kPag).
3. **Purge the gas line** and confirm that the regulator pressure has not changed.

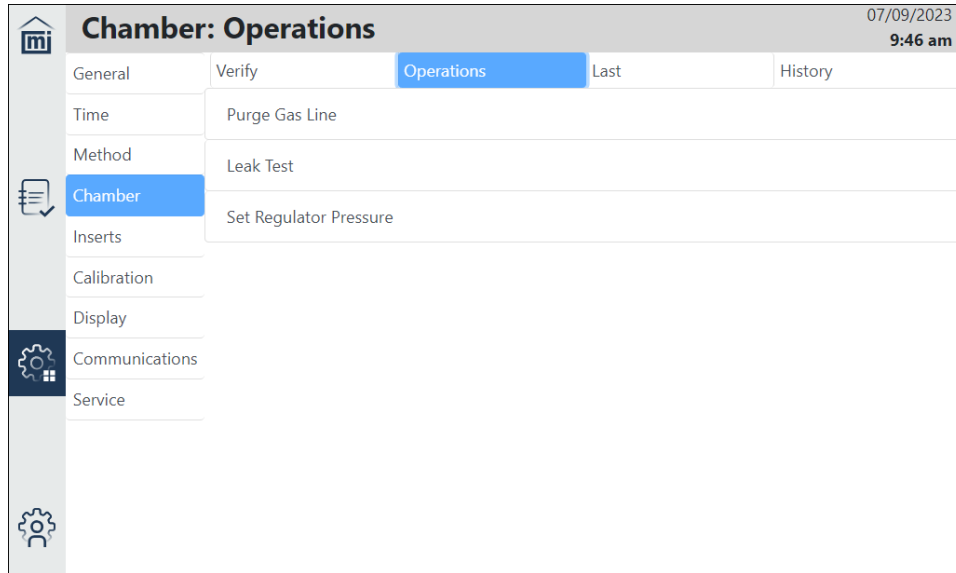

Operations

Operation Name	Description
Leak Test	<p>Checks unit for gas leaks. This should be done as a periodic check or as a diagnostic in the case of unexpected results or errors.</p> <hr/> <div style="display: flex; align-items: flex-start;"> <div> <p>This test should be performed in a temperature-stable environment after the pycnometer temperature has been allowed to equilibrate for at least two hours. Before performing this test, check the chamber cap to ensure that it is not the source of leaks. It should be free from particles, the O-ring should be properly seated, and it should not contain excessive grease.</p> </div> </div> <hr/> <ul style="list-style-type: none"> ■ Ensure the regulator pressure is set to 22 psig (152 kPag) before starting this test.

Operations (continued)

Operation Name	Description
	<ul style="list-style-type: none"> ■ If the system was previously open, perform the Purge Gas Line operation before starting this test. ■ If this test fails, repeat it to verify that a leak is indicated. ■ If a leak is indicated, contact your Micromeritics Service Representative.
Purge Gas Line	Flows gas through the instrument to remove air from the gas line. This should be done any time a gas connection is opened (at the tank, the regulator or the instrument).
Set Regulator Pressure	Follow the on-screen prompts to adjust regulator control knob manually. This should be done after connecting gas lines, replacing the gas cylinder or replacing the regulator. Gas flows continually and vents outside the unit throughout this operation. Pressures should be read from the regulator gauge attached to the gas cylinder.

LAST

Displays the most recent chamber verification. Tap **Export** and select an export type (such as PDF or TXT).

Chamber: Last 16/10/2023 12:24 pm

General Verify Operations **Last** History

Time AccuPyc 1350 10 cm³ (ATC) SN: 0000 21/06/2023, 8:19 am 20.000 °C

Method

Chamber

Inserts

Calibration

Display

Communications

Service

Pass/Fail: Failed

Volume Standard: 0.0000 cm³ - Reference Ball 1

Temperature: 20.000 °C

Gas: Helium

Reference V (20.000 °C): 0.0000 cm³

Tolerance: 0.0020 cm³

V (Sample Expansion): 1.0000 ± 0.0001 cm³

V (Reference Expansion): 1.0000 ± 0.0000 cm³

Export

HISTORY

Displays all chamber verifications that are associated with the most recent calibration. Tap **Export** and select an export type (such as PDF or TXT).



The information that displays on this tab is not a historical listing of all chamber verifications. It is solely based on verifications performed after the most recent calibration. When a new calibration is run, this tab is cleared until the next calibration verification is run.

Chamber: History

16/10/2023
12:26 pm

- General
- Time
- Method
- Chamber
- Inserts
- Calibration
- Display
- Communications
- Service

Verify
Operations
Last
History

	Date	Pressure (psig)	Temp (°C)	Gas	Reference (cm ³)	Sample Filled (cm ³)	Reference Filled (cm ³)	Pass/Fail
Method	21/06/2023	19.500	20.000	Helium	0.0000	1.0000	1.0000	Failed
Chamber	20/06/2023	1.000	20.000	Helium	0.0000	1.0004	1.0000	Failed

INSERTS

Settings > Inserts

Use to configure the type of insert being placed in the chamber: *Multivolume Insert*, *Volume Standard*, *Cup* and *Measure Volume*.

Inserts are used to reduce the available volume within the sample chamber. This allows maximum accuracy to be obtained when using lower sample quantities. Inserts are aluminum cylinders that act as a holder for a new, lower-volume sample cup.

When measuring the volume of a cup, the reference object that came with the instrument or multivolume kit should be used. When measuring a multivolume insert, only the insert needs to be placed in the chamber.

After the volume has been measured, the software will create a file in which the name can be modified. The measured volume and temperature at which the volume was obtained cannot be modified.



Changing these settings doesn't configure the instrument for a particular insert or cup. After an insert or cup is added, it can be selected for a particular method by editing the method's settings (refer to **Settings** > [Method on page 2 - 21](#)).

Also, if an attempt is made to delete an insert or cup linked to an analysis or calibration, an error message displays indicating the insert or cup is still referenced.

To add a new *Multivolume Insert*, *Volume Standard*, or *Cup*, tap the **Plus** sign and enter the applicable details. (*Measure Volume* has a different set of fields than those shown below.)

Name	Insert
Share on MIC NET	<input type="checkbox"/> 
Volume	0.000000 cm ³
Temperature	20.0 °C
Material	Aluminum

Fields	Description
Name	Enter the name of the <i>Multivolume Insert</i> , <i>Volume Standard</i> or <i>Cup</i> . This name must be unique.
Share on MIC NET	Enable to share inserts between instruments connected together through the MIC NET. The instrument with the insert having the latest modification will be shared. Does not apply for <i>Volume Standard</i> .
Volume	Enter the volume of the <i>Multivolume Insert</i> , <i>Volume Standard</i> or <i>Cup</i> . If the cup or multivolume insert has already been measured, this field cannot be edited.
Temperature	Enter the temperature at which the <i>Multivolume Insert</i> , <i>Volume Standard</i> or <i>Cup</i> volume was measured. If the Cup or Multivolume Insert has already been measured, this field cannot be edited.
Material	Select the applicable type of material (such as Aluminum, Stainless Steel, or Tungsten Carbide). When a material is selected, the <i>Thermal Expansion</i> field is not displayed.

MULTIVOLUME INSERT

The names and volumes of sample chamber inserts to be used to reduce empty volume when analyzing small samples.

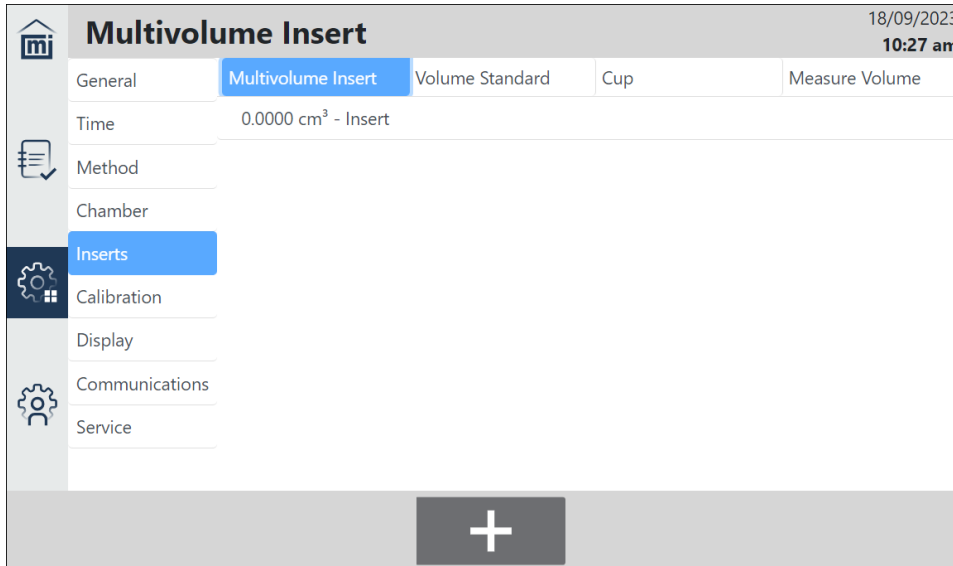

The screenshot shows the 'Multivolume Insert' configuration screen. The top right corner displays the date '18/09/2023' and the time '10:27 am'. The main title is 'Multivolume Insert'. Below the title, there are four tabs: 'General', 'Multivolume Insert' (which is selected), 'Volume Standard', and 'Cup'. At the bottom right of the tabs is a 'Measure Volume' button. The 'Multivolume Insert' tab shows a 'Time' field with the value '0.0000 cm³ - Insert'. On the left side, there is a vertical menu with icons and labels: 'General', 'Method', 'Chamber', 'Inserts' (which is highlighted in blue), 'Calibration', 'Display', 'Communications', and 'Service'. At the bottom center of the screen, there is a large grey button with a white plus sign (+).

VOLUME STANDARD

The names and volumes of reference volumes used to calibrate (and verify accuracy of) sample and reference chamber volumes.

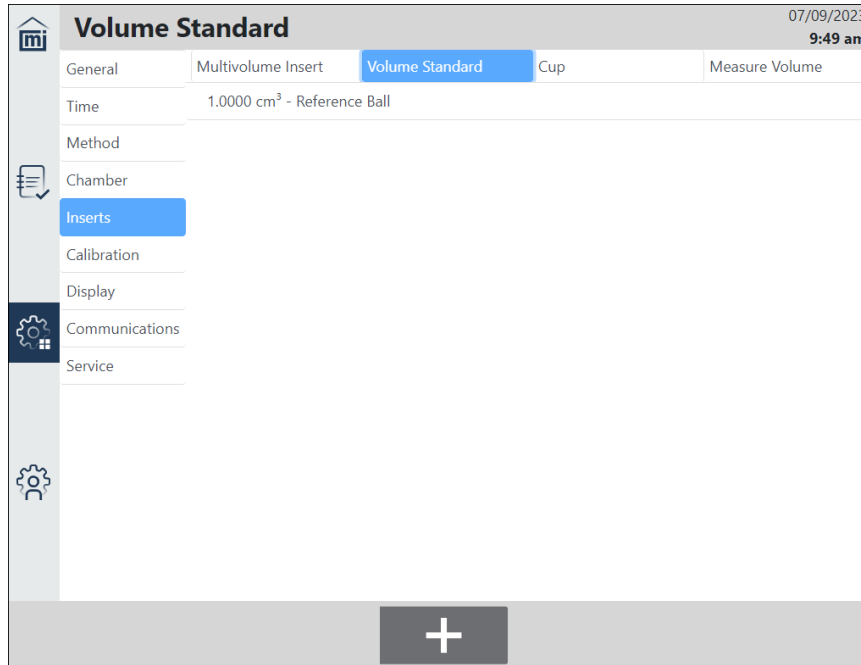

CUP

The names and volumes of sample cups to be used in analyses.

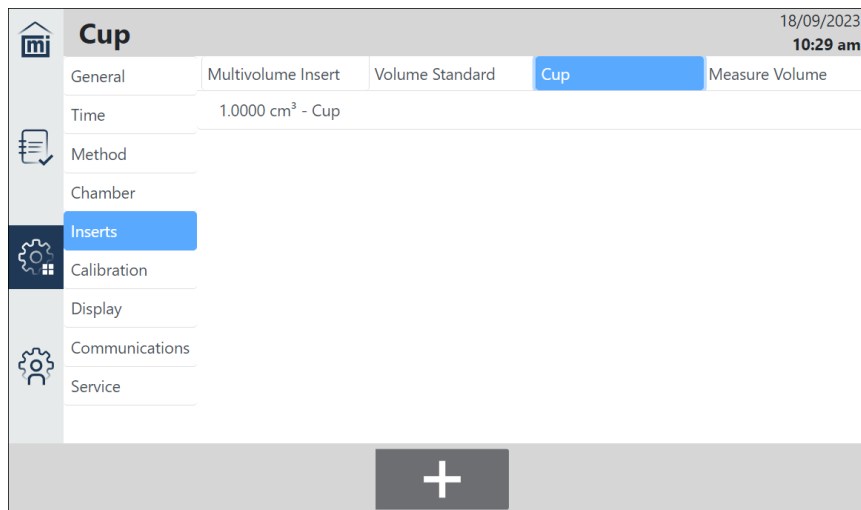

MEASURE VOLUME

Used to measure the volume of a Cup or Multivolume Insert. After the measurement is completed, the Cup or Multivolume Insert is added under the applicable tab.

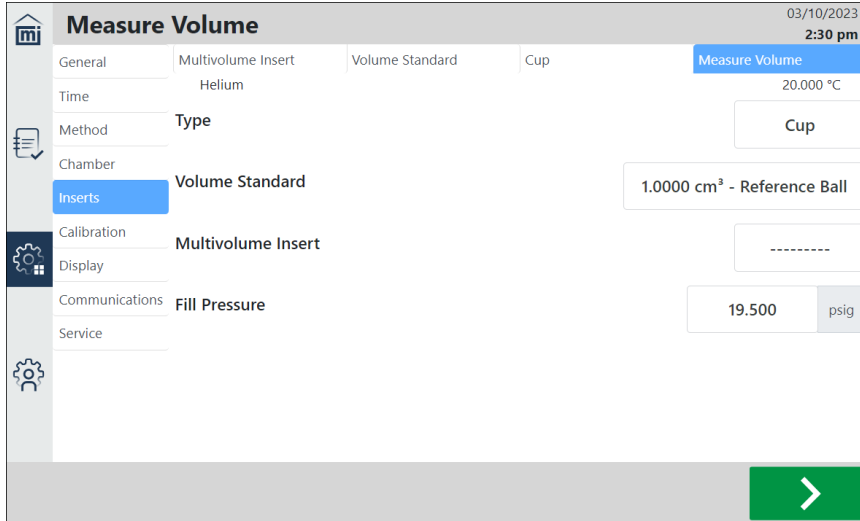

Fields	Description
Type	Select either <i>Insert</i> or <i>Cup</i> .
Volume Standard and Multivolume Insert	When the Type is <i>Cup</i> , an existing Volume Standard and/or Multivolume Insert can be selected and placed in the chamber along with the cup. The pre-set volumes of those items are subtracted out of the measurement to obtain the Cup volume.
Fill Pressure	Key in the Fill Pressure. For most applications, the default of 19.500 psig (134.45 kPag) is adequate.

Tap **Next**. The Measure Volume process begins.

CALIBRATION

Settings > Calibration

Use to view data from current and previous calibrations, perform a calibration to reset any previously run calibrations, and reset to the earliest volume calibration (which does not reset the instrument to the factory defaults).

LAST

Displays the most recent volume calibration.

Refer to the sample chamber volume for the flow path of interest, either *Sample Chamber - Sample Filled* for sample flow path or *Sample Chamber - Reference Filled* for reference flow path.

Tap **Export** and select an export type (such as PDF or TXT).

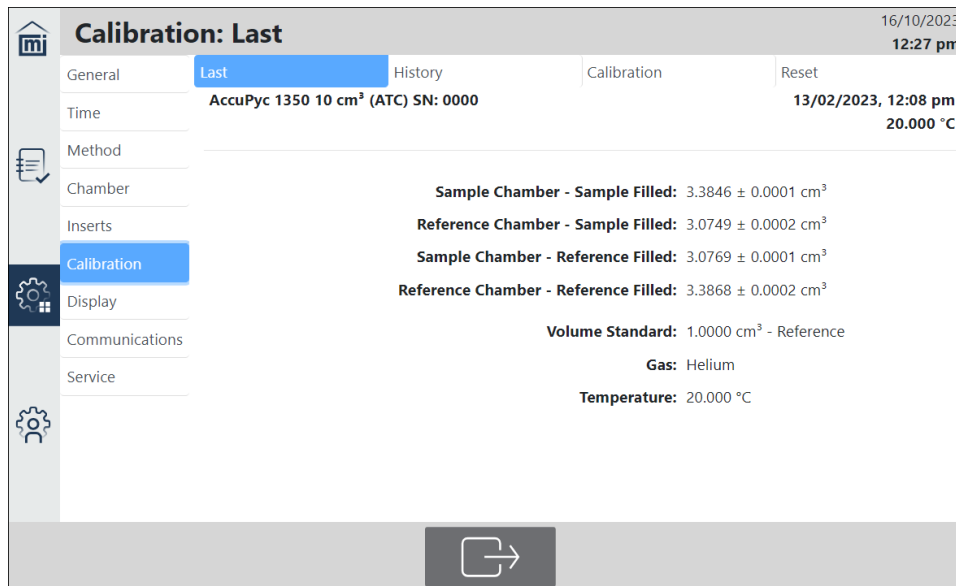

HISTORY

Displays all calibrations performed and includes date, sample and reference-chamber volumes. In addition to the chamber calibration values, a Result column records whether the calibration was “Applied,” “Rejected,” “Factory,” or the result of a “Reset.”

Tap **Export** and select an export type (such as PDF or TXT).

Calibration: History											16/10/2023 12:29 pm	
General	Last	History				Calibration	Reset					
Time		Sample Chamber-Sample Filled (cm ³)	Reference Chamber-Sample Filled (cm ³)	Sample Chamber-Reference Filled (cm ³)	Reference Chamber-Reference Filled (cm ³)		Pressure (psig)	Temp (°C)	Reference Object Gas			
Method												
Chamber												
Inserts												
Calibration	Date					Result						
Display	03/10/2023	1.8334	1.6657	1.6666	1.8345	Rejected	19.500	20.000	1.00	Helium		
Communications	13/02/2023	3.3846	3.0749	3.0769	3.3868	Factory	19.500	20.000	1.00	Helium		
Service												

CALIBRATION

Performs a chamber volume calibration. The first screen provides information about the action to be performed.



Good lab practice is to perform a verification on a regular schedule. 90 days is a reasonable period, or when major changes are made to normal operating conditions (such as temperature differences or switching gases or if a change to the internal chamber is suspected).

If a verification passes, there is no need to calibrate. If a verification fails, a calibration should be done and the cup volume remeasured.



This process can take several hours. During the process a message displays indicating that the sample chamber should be empty. Tap **Next**. As the process continues, a message displays indicating to insert the calibration standard. Tap **Next** to continue the process.



If a chamber volume calibration is performed, all existing values are overwritten.

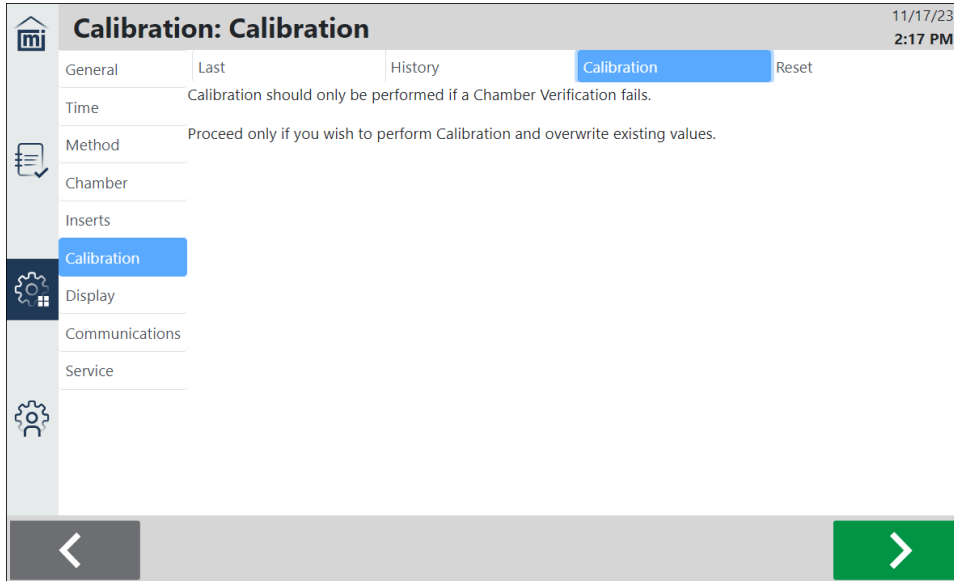

Tap **Next** to move to the screen where the *Volume Standard* and *Fill Pressure* are configured.

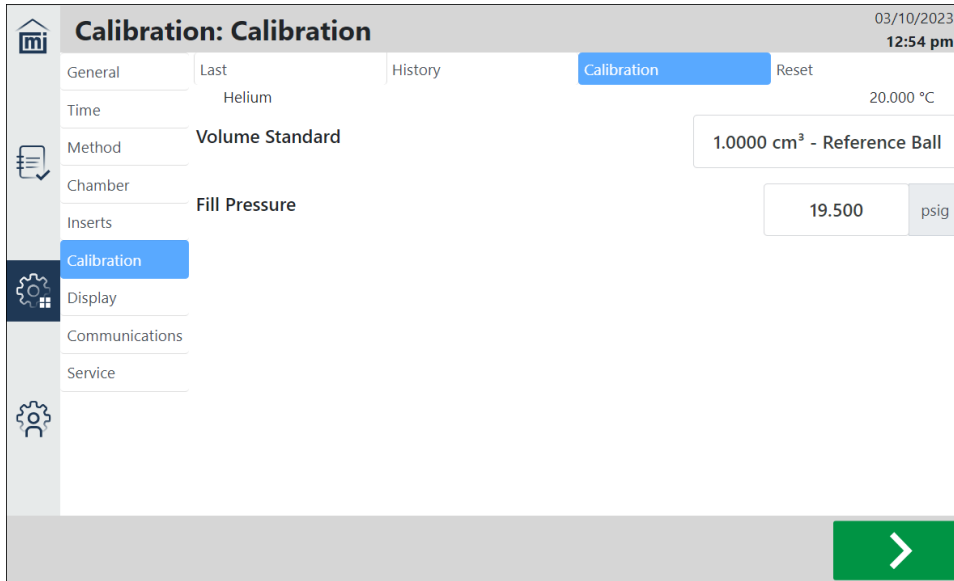

Calibration

Fields	Description
Volume Standard	Specifies the size of the cup placed in the chamber along with the cup. The pre-set volumes of those items are subtracted out of the measurement to obtain the cup volume.
Fill Pressure	Key in the Fill Pressure. For most applications, the default of 19.500 psig (134.45 kPag) is adequate.

Tap **Next** to continue the calibration process.

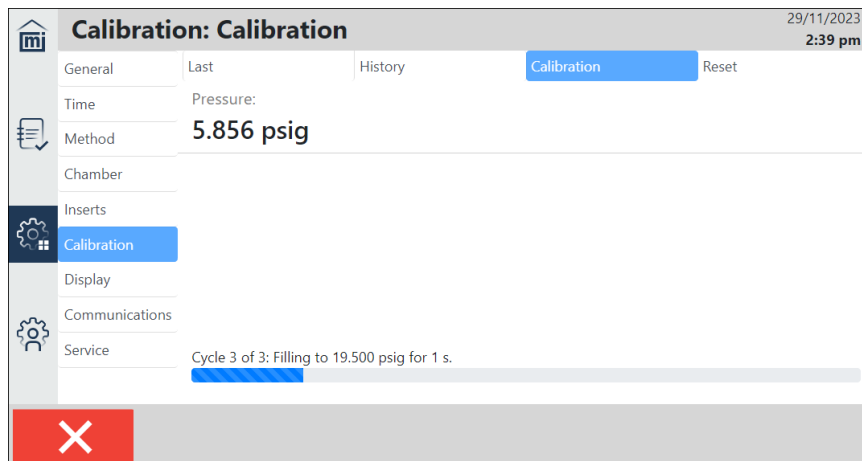

- If the prompt, "Make sure the sample chamber is empty" displays, verify the sample chamber is empty and tap **Next**. The process continues.
- If the prompt, "Insert the Calibration Standard" displays, insert the calibration standard and tap **Next**. The process continues.

When the calibration is complete, the results are displayed. The chamber volumes are shown in comparison to the values that were in place prior to the current calibration. One of the following occurs:

- **Rejected by system condition.** The calibration is rejected and an error displays if any of the measured volumes change by more than 0.2% compared to the initial factory calibration or the most recent volume calibration. Refer to the Appendix C - [Error Messages on page C - 1](#) for suggested corrective actions, check the system and try again, or contact your Micromeritics Service Representative.
- If the operation is within system limits, the system prompts, "Do you want to accept the new calibration?" Tap **Yes** to apply the calibration. Tap **No** to reject the calibration.

RESET

Resets the calibrated chamber volume to those configured when the instrument was manufactured.

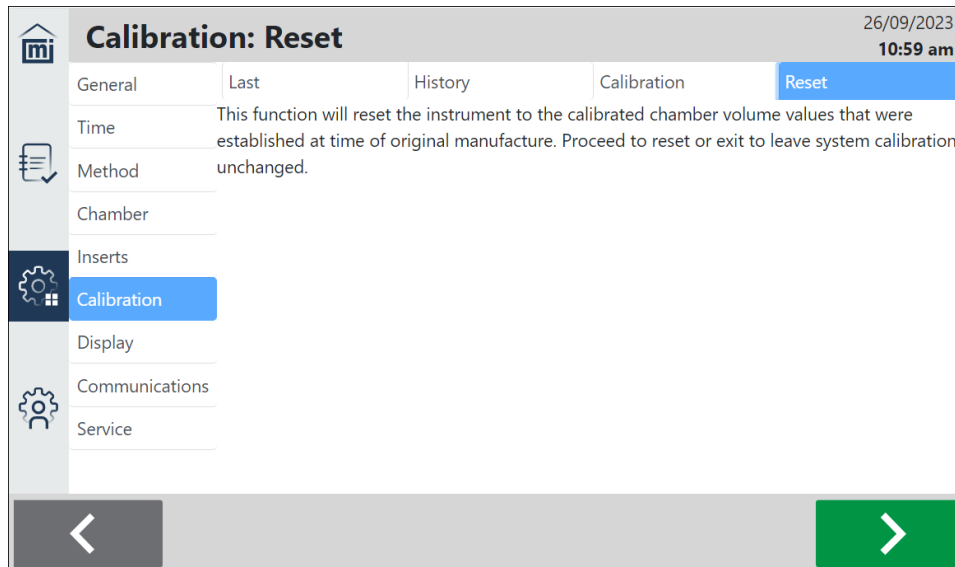

Tap **Next** to proceed with the reset.

DISPLAY

Settings > Display

Use to configure the instrument display defaults.

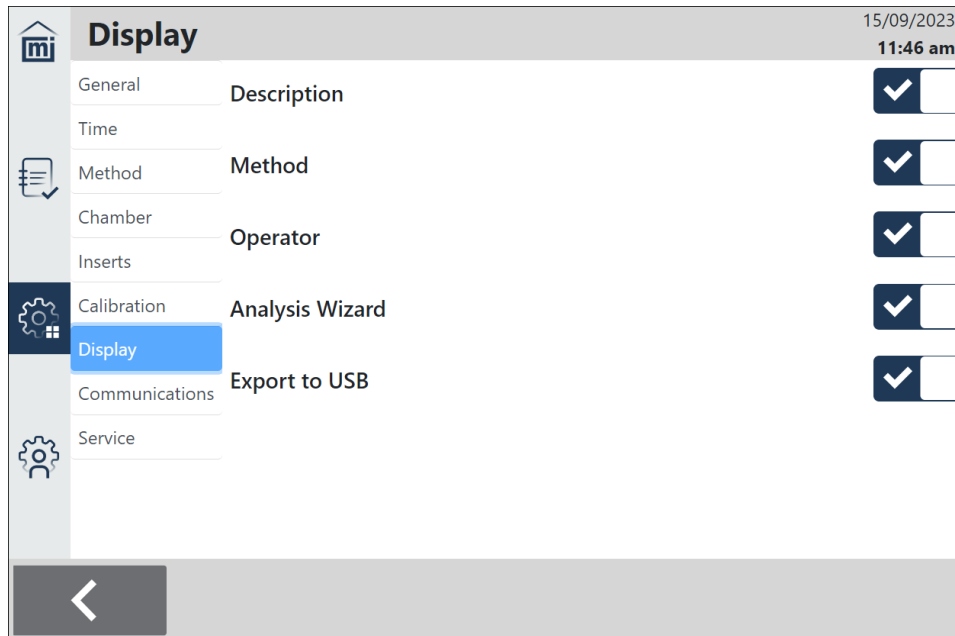

Display

Selections	Description
Description	Enables the <i>Description</i> field on the Analysis screen.
Method	Enables the <i>Method</i> field on the Analysis screen.
Operator	Enables operator-related activity including the following: <ul style="list-style-type: none"> On the <i>Analysis</i> screen, displays the <i>Operator</i> field. On the <i>Records</i> screen, allows for sorting of records by Operator and displays the Operator information.
Analysis Wizard	Enables the <i>Analysis Wizard</i> . When selected, a guide for loading a sample is displayed before an analysis starts.
Export to USB	Enables exporting of data to a USB drive.

COMMUNICATIONS

Settings > Communications

Use to set up communication defaults.

TCP/IP

Settings > Communications > TCP/IP

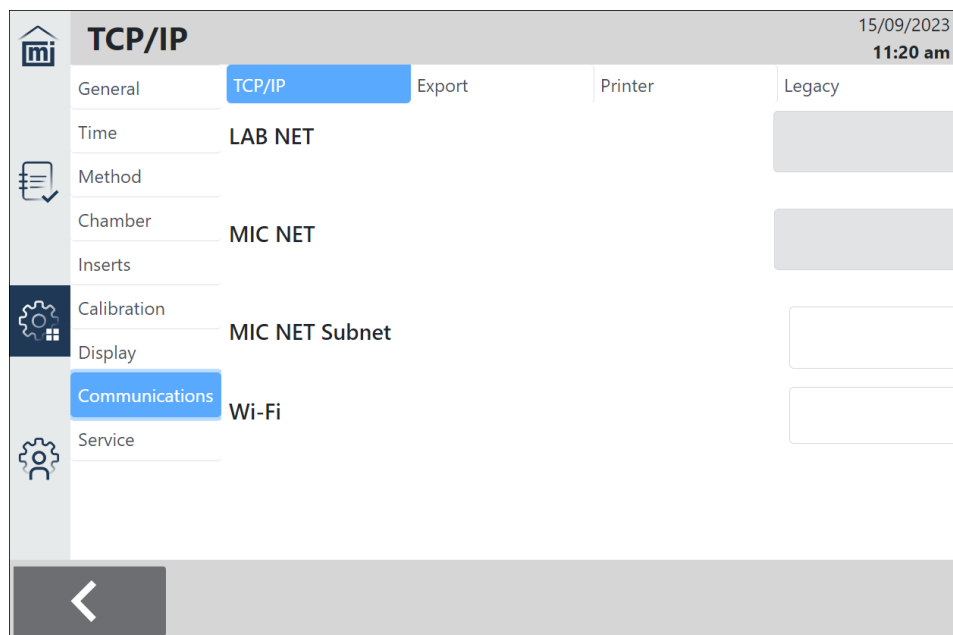

TCP/IP

Fields	Description
LAB NET	Displays the IP address (if available) on the lab network when the instrument is connected with an Ethernet cable. The lab network's DHCP server assigns an IP address automatically. It is only shown if the instrument is connected over DHCP. To operate the instrument remotely, enter this address in a web browser on another computer connected to the same network.
MIC NET	Displays the IP address on the Micromeritics network. The instruments coordinate their IP addresses on this network internally. This is a local network that allows 1350s and legacy instruments to share data when they are directly connected to each other with Ethernet cables.
MIC NET Subnet	Displays the subnet IP address the MIC NET uses when it sets IP addresses. The subnet choice must not conflict with the LAB NET or

TCP/IP (continued)

Fields	Description
	Wi-Fi subnets. For example, if the LAB NET IP address starts with 192.168, the MIC NET Subnet must not start with 192.168.
Wi-Fi	Displays available Wi-Fi networks. Select the applicable network. The Wi-Fi network's DHCP server assigns an IP address automatically. The Wi-Fi IP address is only shown if the instrument is connected over DHCP. Once a Wi-Fi network is selected, a password entry screen is also shown. To operate the instrument remotely, enter this address in a web browser on another computer connected to the same network.

EXPORT

Settings > Communications > Export

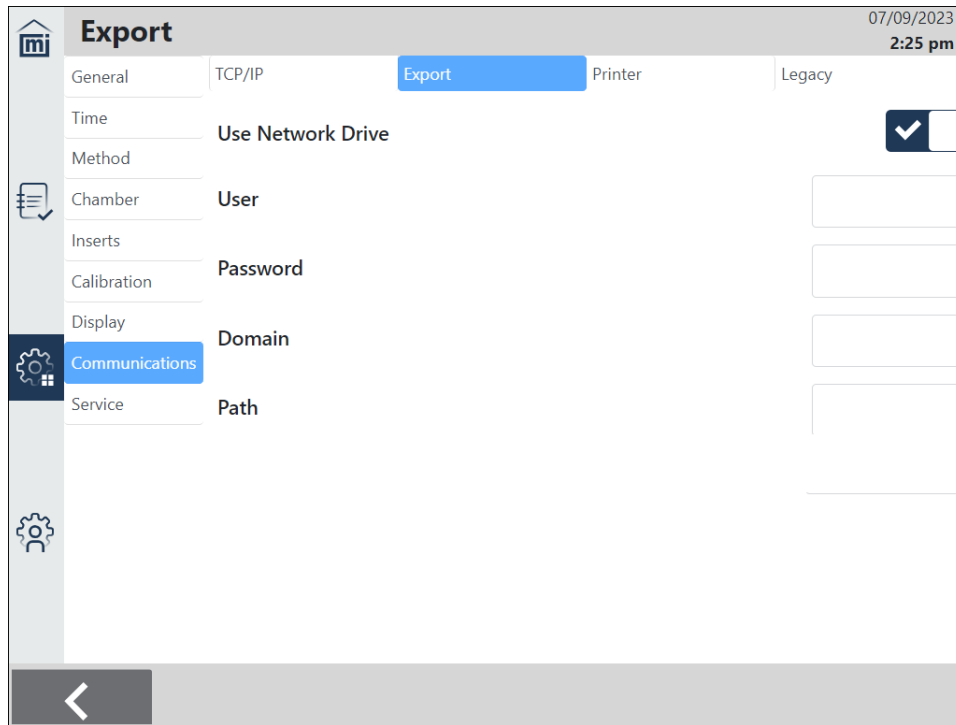

Export

Fields	Description
Use Network Drive	Specifies if analysis data can be exported to a network drive. When selected, additional fields display as described below.
User	Name of the user with permission to access the network drive.
Password	Password that corresponds to the user.
Domain	Domain associated with the network drive.
Path	Path to network drive.

PRINTER

Settings > Communications > Printer

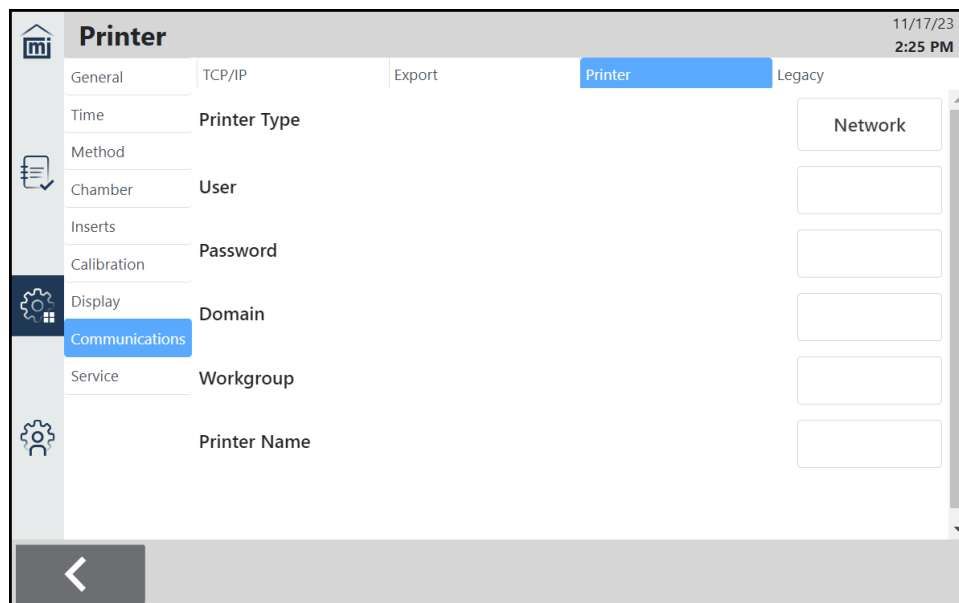

Network Printer

Fields	Description
Printer Type	Type of network to which the printer is connected.
User	Name of the user with permissions to access the printer.
Password	Password that corresponds to the user.
Domain	Name of the domain associated with the printer.
Workgroup	Name of the workgroup associated with the printer.
Printer Name	Name of the printer.

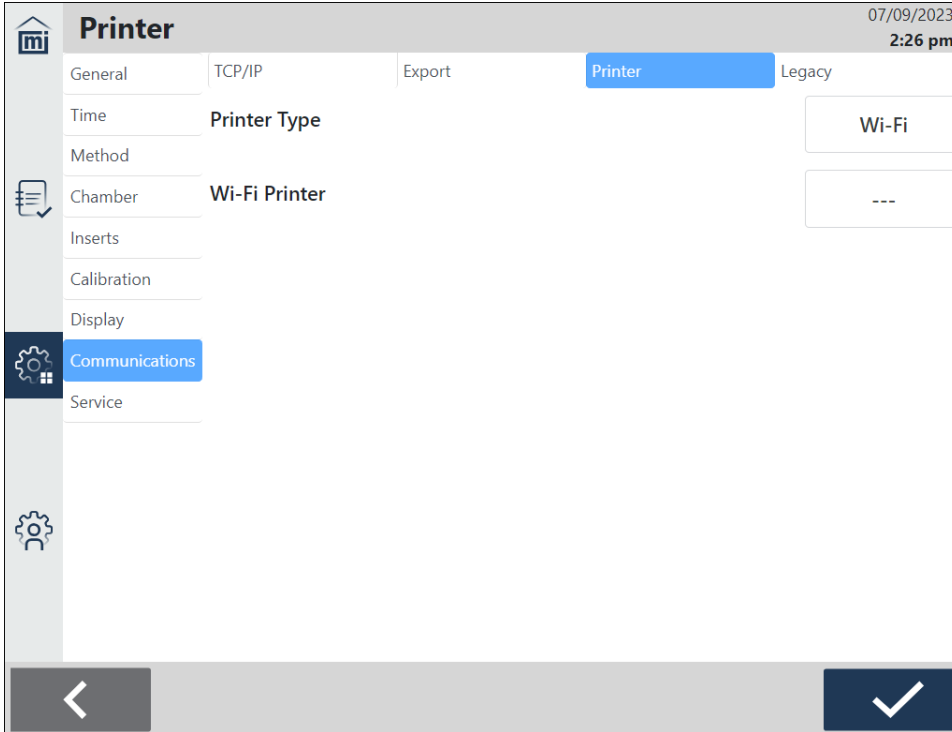

Wi-Fi Printer

Fields	Description
Printer Type	Type of network to which the printer is connected.
Wi-Fi Printer	Selects the applicable Wi-Fi printer.

LEGACY INSTRUMENT

Use to view and add any legacy AccuPyc instruments connected to the 1350, such as the 1345 or 1340. When configured, the analysis results from the legacy instrument display in the records list and also in the report header. The software will check periodically for new results and load them.



For the 1345 and 1340, only the last five results are stored. Thus, earlier results are not available.

1. Tap **Settings > Communications > Legacy**.

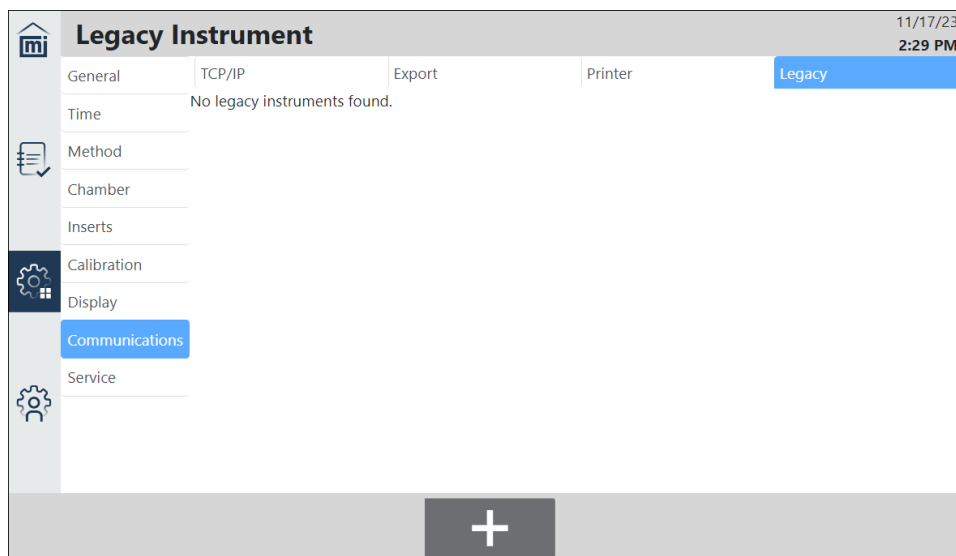

2. Tap the **Plus** sign.
3. Enter the *IP Address* for the legacy instrument.
4. Tap **Save**.

HELP

Use this menu to view instrument details, tips, practices, videos, and activity log.

ABOUT

Displays information about the AccuPyc III instrument.

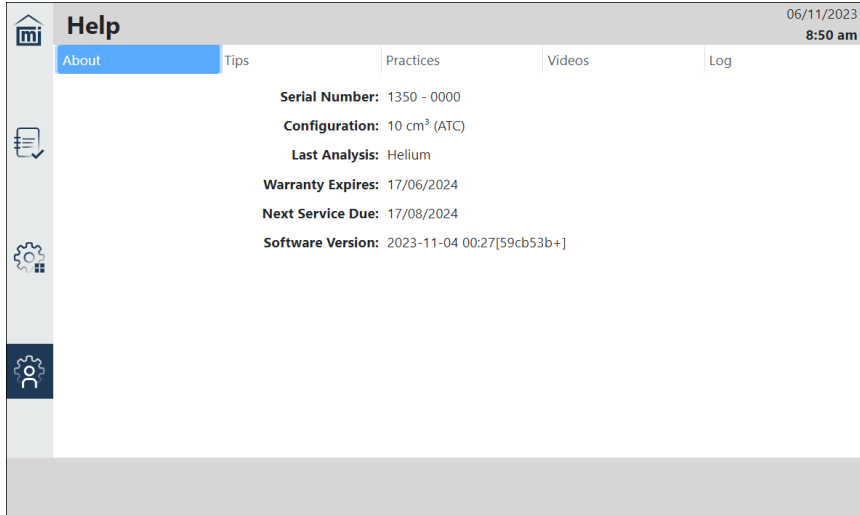

The screenshot shows the 'Help' menu with the 'About' tab selected. The instrument details are as follows:

Property	Value
Serial Number	1350 - 0000
Configuration	10 cm ³ (ATC)
Last Analysis	Helium
Warranty Expires	17/06/2024
Next Service Due	17/08/2024
Software Version	2023-11-04 00:27[59cb53b+]

TIPS

Contains links to helpful tips information.

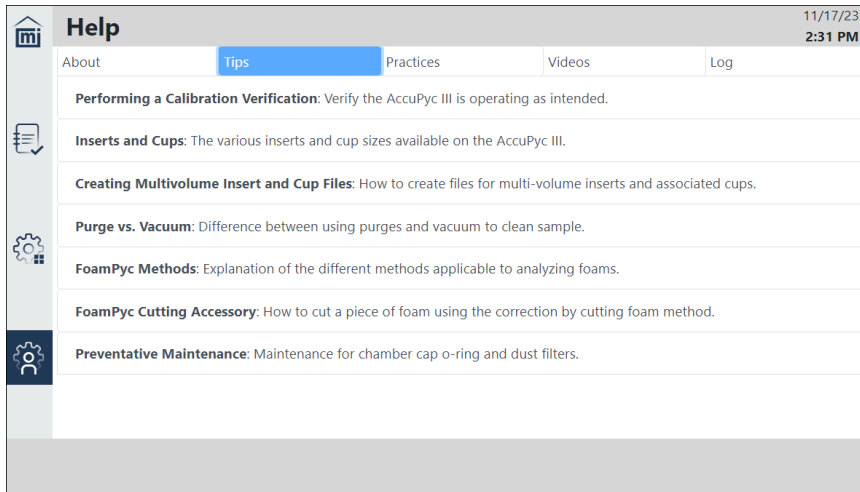

The screenshot shows the 'Help' menu with the 'Tips' tab selected. The tips are as follows:

- Performing a Calibration Verification:** Verify the AccuPyc III is operating as intended.
- Inserts and Cups:** The various inserts and cup sizes available on the AccuPyc III.
- Creating Multivolume Insert and Cup Files:** How to create files for multi-volume inserts and associated cups.
- Purge vs. Vacuum:** Difference between using purges and vacuum to clean sample.
- FoamPyc Methods:** Explanation of the different methods applicable to analyzing foams.
- FoamPyc Cutting Accessory:** How to cut a piece of foam using the correction by cutting foam method.
- Preventative Maintenance:** Maintenance for chamber cap o-ring and dust filters.

PRACTICES

Contains links to best practice information.

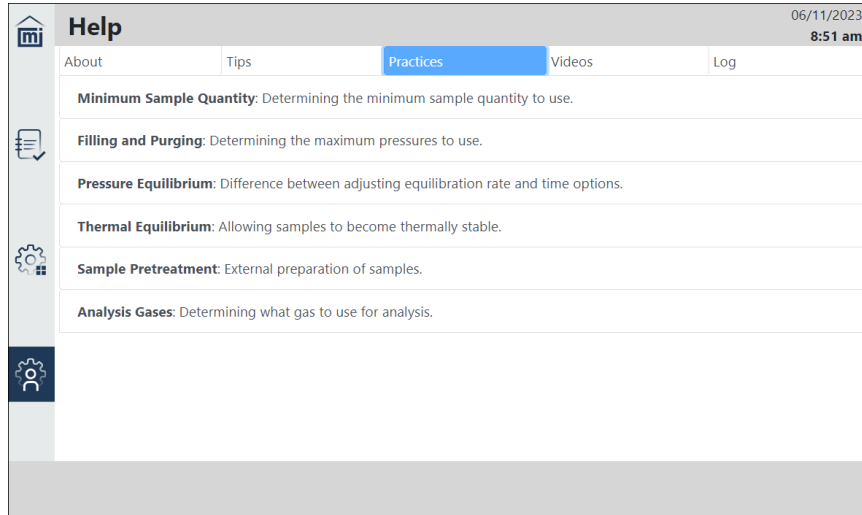

The screenshot shows the 'Help' page with the 'Practices' tab selected. The page title is 'Help' and the date is '06/11/2023 8:51 am'. The navigation menu includes 'About', 'Tips', 'Practices', 'Videos', and 'Log'. The main content area lists several practice topics:

- Minimum Sample Quantity:** Determining the minimum sample quantity to use.
- Filling and Purging:** Determining the maximum pressures to use.
- Pressure Equilibrium:** Difference between adjusting equilibration rate and time options.
- Thermal Equilibrium:** Allowing samples to become thermally stable.
- Sample Pretreatment:** External preparation of samples.
- Analysis Gases:** Determining what gas to use for analysis.

VIDEOS

Contains links to instructional videos.

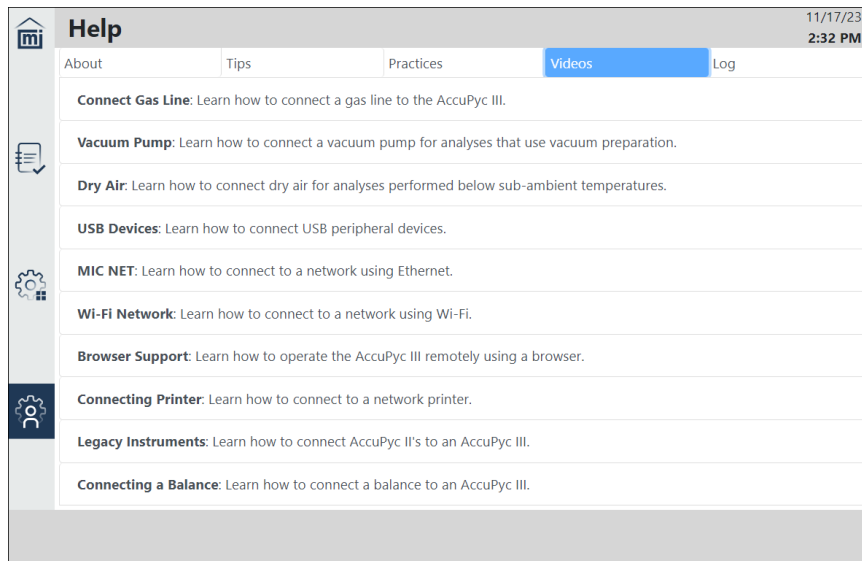

The screenshot shows the 'Help' page with the 'Videos' tab selected. The page title is 'Help' and the date is '11/17/23 2:32 PM'. The navigation menu includes 'About', 'Tips', 'Practices', 'Videos', and 'Log'. The main content area lists several video topics:

- Connect Gas Line:** Learn how to connect a gas line to the AccuPyc III.
- Vacuum Pump:** Learn how to connect a vacuum pump for analyses that use vacuum preparation.
- Dry Air:** Learn how to connect dry air for analyses performed below sub-ambient temperatures.
- USB Devices:** Learn how to connect USB peripheral devices.
- MIC NET:** Learn how to connect to a network using Ethernet.
- Wi-Fi Network:** Learn how to connect to a network using Wi-Fi.
- Browser Support:** Learn how to operate the AccuPyc III remotely using a browser.
- Connecting Printer:** Learn how to connect to a network printer.
- Legacy Instruments:** Learn how to connect AccuPyc II's to an AccuPyc III.
- Connecting a Balance:** Learn how to connect a balance to an AccuPyc III.

LOG

Contains instrument log messages that can be printed and exported.

- Tap **Print** to send the data to the configured network printer (**Settings** > [Communications on page 2 - 41](#)).
- Tap **Export** and select export method and file type (such as PDF or TXT).

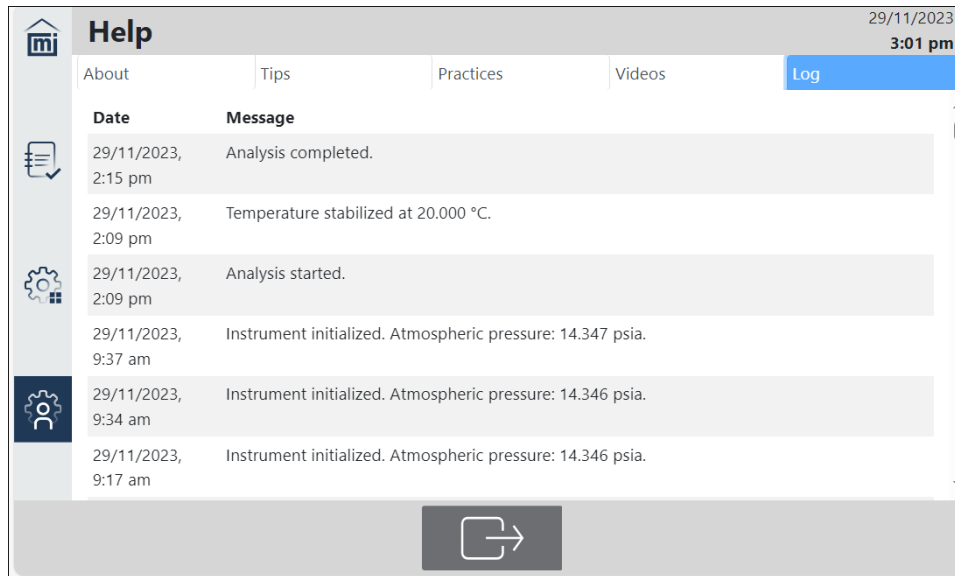

SOFTWARE UPDATES

Use to update the current software version, either through a network connection or an external USB drive.

- If the instrument is connected to a **network**, the instrument is set to automatically download updates from the Micromeritics website.
- To use a **USB drive**, go to the Micromeritics website, and download and unzip the files. Copy the files to a USB drive.

INSTALL THE UPDATE

1. Connect to the network (if not connected) or insert the USB drive (if not inserted).
2. Tap **Settings > General**.
3. Tap **Software Update Available**.
4. Tap **Install Now**.
5. When prompted, tap **Yes**.

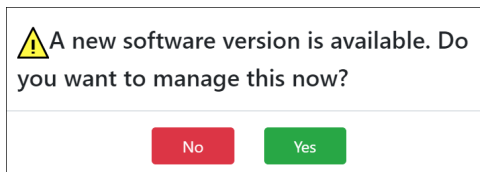

6. Make a selection.

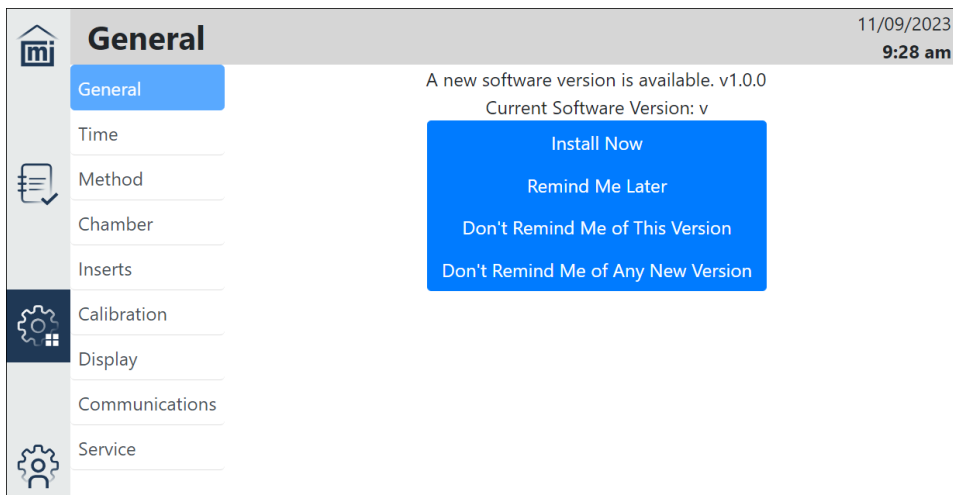

SERVICE

Settings > Service

The Service menu is a password-protected screen that can only be accessed by a qualified Micromeritics Service Representative.

SAVE DIAGNOSTICS TO USB

If hardware problems are encountered with the instrument, and direction has been given by a qualified Micromeritics Service Representative to export diagnostic data, do the following:

1. Insert a USB drive into any USB port.
2. Tap **Settings > Service**.
3. Tap **Save Diagnostics to USB**. The files are saved as a .zip file. Send this .zip file to a Micromeritics Service Representative for review and troubleshooting.

3 MAINTENANCE AND TROUBLESHOOTING

Parts and accessories are located on the [Micromeritics](#) web page.



Improper handling, disposing of, or transporting potentially hazardous materials can cause serious bodily harm or damage to the instrument. Always refer to the SDS when handling hazardous materials. Safe operation and handling of the instrument, supplies, and accessories are the responsibility of the operator.



Do not modify this instrument without the authorization of Micromeritics Service Personnel.



When lifting or relocating the instrument, use proper lifting and transporting devices for heavy instruments. Ensure that sufficient personnel are available to assist in moving the instrument. The AccuPyc 1350 weighs approximately 11.5 kg (25.3 lb).



Use of a power cord or power supply not provided with the instrument could cause personal injury or damage to the equipment. If a replacement is needed, contact your Micromeritics Service Representative. Detachable power supply cords with an inadequate rating could cause significant instrument damage or physical harm.

Do not add anything between the power cord and the power source that would compromise the earth ground.

Do not remove or disable the grounding prong on the instrument power cord.

The analyzer has been designed to provide efficient and continuous service; however, certain maintenance procedures should be followed to obtain the best results over the longest period of time. When unexpected results occur, some common operational problems not indicated on the window and their respective causes and solutions are provided. Refer to [Error Messages on page C - 1](#).

SAFE SERVICING



Do not service or modify this instrument without the authorization of Micromeritics Service Personnel.

To ensure safe servicing and continued safety of the instrument after servicing, service personnel should be aware of the following risks:

Product specific risks that may affect service personnel:

- **Electrical.** Servicing or repair could require opening the outer panels and exposing energized electrical components.
- **High temperatures.** Temperature controlled components internal to the instrument may be hot and could pose a burn hazard to service personnel.

Protective measures for these risks:

- **Electrical.** The electrical components operate at low voltage (24V or less) and pose low risk when energized. However, maintenance, troubleshooting, and repairs should be performed with the instrument de-energized whenever possible, in accordance with standard electrical safety guidelines.
- **High temperatures** Ensure the temperature control is off and verify temperature control components are near ambient temperature before servicing.

Verification of the safe state of the instrument after repair:

- All instrument panels and covers installed.
- Gas lines connected and pressurized to normal operating pressure with no leaks.

POWER

The AccuPyc III uses a 24 V, 11.7 amp power supply with an input range of 100-240 VAC ($\pm 10\%$), 280 VA, 50-60 Hz. Noise-free power of the correct voltage and frequency, with a safety earth ground, should be available through a standard wall receptacle. There should also be sufficient outlets and easy access to those outlets for all devices.



The external power adapter required for the AccuPyc III is Micromeritics' part number 003-40001-02. Use of any other power adapter could damage equipment and/or cause harm to the operator. The AccuPyc III is intended to be powered from the output of the approved power adapter rated Class I, manufactured by Mean Well, P/N GST280A24-C6P. Micromeritics supplies a suitably rated approved power supply cord appropriate for the applicable country with the power adapter.



The analyzer and peripheral devices **must** be installed on their own dedicated power line. Other devices — such as motors, generators, or ovens — **should not** be placed on the same power line.



Replacement power supply cords must be rated for the specifications stated above.



This instrument does not have a power switch and must be disconnected from the wall outlet when powering off; therefore it is important to position the instrument where the wall outlet is easily accessible.

POWER CABLE

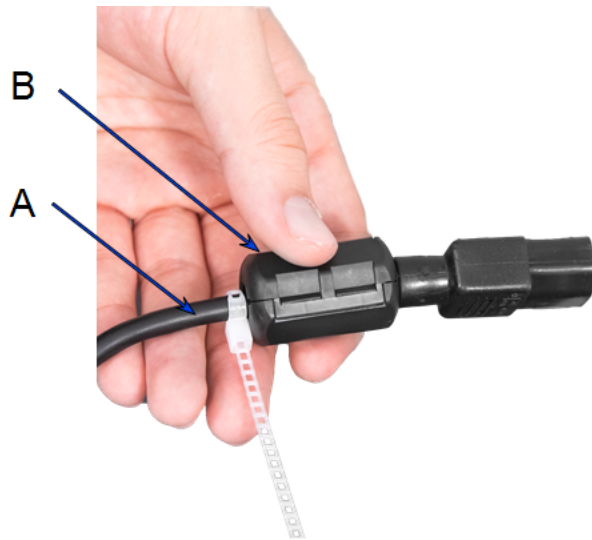

- A. Power Cable
- B. Ferrite Assembly

1. Snap the ferrite component closed around the power cable near the instrument.
2. Install the cable tie around the cable at the end of the ferrite and click the extra tie material.
3. Insert the power cable with ferrite assembly into the power outlet on the instrument.

ETHERNET CABLE

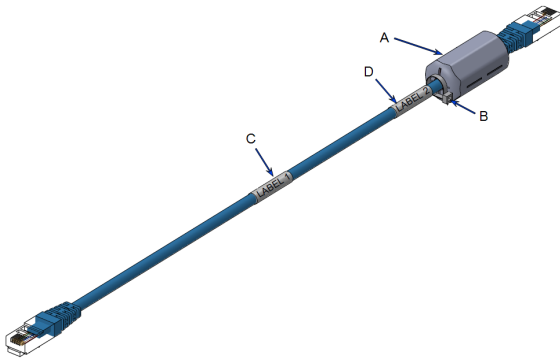

- A. Ferrite
- B. Cable Tie
- C. Label 1. Text shows Part Number, Revision Level, and Work Order Information.
- D. Label 2. Text reads "Instrument side."

1. Install the ferrite on the end of one side of the cable.
2. Install the cable tie to secure the ferrite in place, and clip off excess tie material.
3. Mark and install label 1 on the middle of the cable.
4. Mark and install label 2 near the ferrite.

CHAMBER CAP

- When closing the cap, turn the handle until it stops. Ensure that the Micromeritics logo on the handle is upright.
- Leave the cap closed whenever the instrument is idle to prevent contaminants and ensure that background purges proceed normally.

CHAMBER CAP O-RING

The cell chamber cap contains an O-ring that requires routine maintenance. A small amount of high vacuum grease should be distributed evenly around the O-ring. If the O-ring shows signs of wear, it should be replaced with a new, greased O-ring. The chamber cap O-ring should be greased at the beginning of each period of use.

Fine fibers and particles between the O-ring and its sealing surfaces can cause leaks, as can scratches or cuts in the O-ring or in the metal surfaces.

GREASE THE CHAMBER CAP O-RING

1. Open the chamber cap.
2. Use a small drop of Dow Corning high vacuum grease (or equivalent).
3. Distribute the grease evenly and completely around the O-ring groove.
4. Close the chamber cap.
5. If recalibrating the pycnometer, allow the pycnometer temperature to stabilize for 30 minutes before calibrating.

REPLACE THE CHAMBER CAP O-RING

1. Use a pointed tool and carefully remove the O-ring from its groove in the cap. A small niche is provided at the groove for placement of the tool.





Do not to scratch the metal surface of the chamber cap. Scratches could result in an imperfect seal.

2. Clean the groove in the chamber cap using a small brush or clean, lint-free tissue moistened with isopropyl alcohol.
3. Allow the chamber cap to dry thoroughly.
4. Use a small drop of Dow Corning high vacuum grease (or equivalent).
5. Grasp the O-ring with the two greased fingers. Distribute the grease evenly and completely around the O-ring.



Apply the grease sparingly. Too much grease may alter cell volume while too little grease results in an imperfect seal and leaks.

6. Place the O-ring back into the groove on the cap and, with the greased index finger, gently press it back into position.
7. Ensure the O-ring groove is properly greased. See [Chamber Cap O-Ring on the previous page](#).
8. Close the chamber cap.

CLEAN THE PYCNOMETER

Exterior surfaces should be cleaned with soap or mild detergents. Cleaning agents should be applied with a soft cloth. Do not use solvents or abrasives as they may damage some surfaces.

The air intake filters at the rear of the instrument should be inspected periodically and rinsed or replaced if they are clogged. Clogged filters may impair the instrument's temperature control and could damage the TEC.



A fan is used to exchange heat with the TEC module. Air is pulled from the underside at the back of the instrument and exhausted out the back. Ensure that the back of the instrument is not obstructed by cables or debris. Ensure that area behind the fan grille is clear. Obstructed airflow could impair temperature control and could damage the TEC.



Do not immerse the pycnometer or the power cord in any liquids. Doing so could result in electrical shock to personnel or damage to the unit.



Do not allow liquid to penetrate the casing of the pycnometer. Doing so could result in damage to the unit.

DECONTAMINATION OF THE PYCNOMETER



Always wear personal protection equipment appropriate for the type and level of contamination.

In addition to following the instructions to clean the pycnometer, service personnel should use compressed air to decontaminate internal components.

BLOCK CONDENSATION

Condensation on the insulation around the sample block can potentially occur when a dry air purge has not been performed.

Do the following to resolve the issue:

1. Allow the instrument to come to room temperature.
2. Use an absorbent wipe or towel to remove the standing water.
3. Eliminate the remaining water by setting the block temperature to 40 °C while running dry air purge at 250sccm for several hours.
4. Verify that the insulation around the sample block is dry before continuing.

If the above steps do not rectify the problem, contact Micromeritics Service Personnel for assistance.

To prevent condensation in the future, review the humidity requirements as found in the *Specifications* for this instrument. If it is not possible to lower the humidity of the room, try increasing the dry air purge flow rate (up to a maximum of 1000sccm, if necessary).

GUIDELINES FOR CONNECTING GASES

Regulator Pressure Settings

Analyzer	Gauge should indicate
AccuPyc	22 psig (152 kPag)



Exceeding the maximum recommended pressure could cause personal injury or damage the instrument.



These instructions refer to the installation of a gas line, regulator, and gas cylinder for each type of gas used. If expansion kits or other accessories are used in the lab, special consideration should be given to these configurations when installing the gas lines.



Improper handling, disposing of, or transporting potentially hazardous materials can cause serious bodily harm or damage to the instrument. Always refer to the SDS when handling hazardous materials. Safe operation and handling of the instrument, supplies, and accessories are the responsibility of the operator.

- Place gas cylinders within 6 feet (2 m) of the gas inlets of the analyzer. Place the cylinders close enough to allow for proper connection at the analyzer inlet.

Using gas line extenders on gas cylinders located in remote areas may degrade gas quality and reduce pressure.

Long gas lines, such as those used with gas cylinders placed in remote areas, must be purged for an extended period of time to remove ambient gases. When possible, avoid placing gas cylinders in remote locations. It is always best to have gas cylinders located near the analyzer.

- Use a retaining strap (or other appropriate tether) to secure the gas cylinder.
- Always use the gas lines provided with the analyzer. It is very important that proper gas lines are used with the analyzer.
 - **Do not use** polymer tubing for the gas line.
 - **Do not use** flexible gas lines. Some flexible lines may appear to be appropriate, such as those with a herringbone covering, but the line may be coated internally with a polymer.
- Carefully route the gas lines from the cylinder to the analyzer avoiding overlapping or entangling gas lines. This will help avoid confusion when maintenance is required.
- Label the gas line at the analyzer inlet for proper identification and maintenance.

- Replace gas cylinders before gas is depleted. It is best to replace a gas cylinder when the pressure reads approximately 600 psi or 4100 kPa on the high-pressure gauge. Contaminants adsorbed to the walls of the cylinder will desorb as the pressure decreases.
- Ensure the gas cylinder is closed before connecting to the analyzer. Then run the *Purge Gas Line* operation.

REPLACE A GAS CYLINDER

Regulator Pressure Settings

Analyzer	Gauge should indicate
AccuPyc	22 psig (152 kPag)



Exceeding the maximum recommended pressure could cause personal injury or damage the instrument.

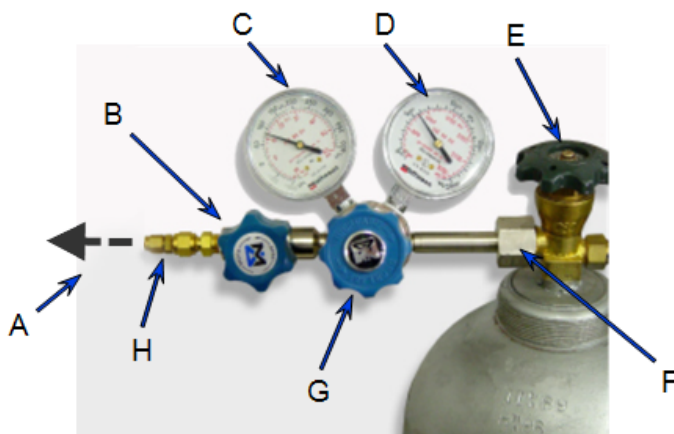

- A. Gas tubing to instrument
- B. Gas regulator shut-off valve
- C. Low pressure gauge
- D. High pressure gauge
- E. Gas cylinder shut-off valve
- F. Regulator connector nut
- G. Regulator control knob
- H. Brass reducer fitting

Disconnect a Depleted Gas Cylinder

1. Close the regulator shut-off valve and gas cylinder shut-off valve by turning the knobs clockwise.
2. Disconnect the gas line from the regulator. Gas will be vented from the line. It is not necessary to disconnect the gas line from the analyzer inlet if the cylinder will be replaced immediately with one of the same type.
3. Open the gas regulator shut-off valve by turning the knob counter-clockwise. Gas will be vented from the regulator.
4. Turn the regulator control knob clockwise to open and vent any remaining gas. Both gauges should read at or near zero. If not, make sure the gas regulator shut-off valve is open.
5. Close the regulator by turning the control knob counter-clockwise.
6. Use an appropriate wrench to loosen the nut at the regulator connector nut then remove the regulator from the cylinder.
7. Replace the protective cap on the depleted cylinder. Disconnect the retaining strap and move the cylinder to an appropriate location.

Connect a Gas Cylinder

1. Use an appropriate cylinder wrench to remove the protective cap from the replacement gas cylinder.
2. Place the protective cap in a secure location. It will be needed to recap the gas cylinder when it is depleted and replaced.
3. Attach the gas regulator to the gas cylinder connector. Hand tighten the nut, then use an appropriate wrench to tighten an additional 3/4 turn.



Over-tightening the fitting may cause a leak.

4. Check for leaks at the high pressure side of the regulator and in the connector.
 - a. Turn the regulator control knob fully counter-clockwise.
 - b. Slowly open the gas cylinder shut-off valve, then quickly close it.
 - c. Observe the pressure on the high pressure gauge for approximately one minute.
 - If the pressure is stable, proceed with the next step.
 - If the pressure decreases, tighten the regulator connector nut until it becomes stable. If the pressure does not remain stable, remove the regulator and clean all contacts at the regulator connection, then reinstall the regulator.



For the following steps, refer to [Operations on page 2 - 28](#).

5. Connect the gas line to the regulator and the instrument and perform a leak test.
6. Set the regulator pressure until the low pressure gauge reads 22 psig (152 kPag).
7. Purge the gas line and confirm that the regulator pressure has not changed.

REGULATOR PRESSURE



Tank pressure should be at least 200 psi above regulator pressure. Pressures less than 200 psi indicates the tank is low on gas.

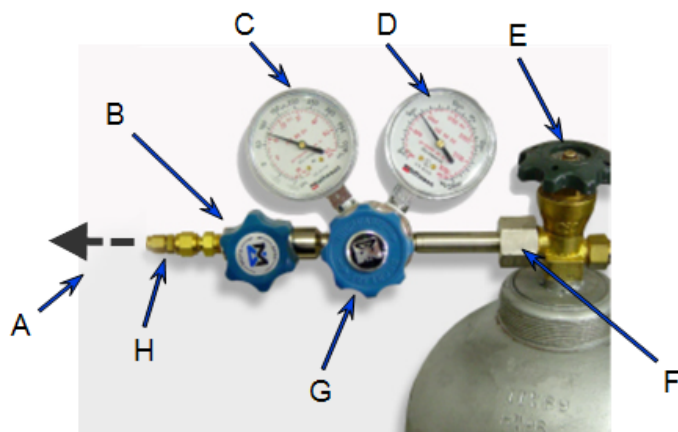

- A. Gas tubing to instrument
- B. Gas regulator shut-off valve
- C. Low pressure gauge
- D. High pressure gauge
- E. Gas cylinder shut-off valve
- F. Regulator connector nut
- G. Regulator control knob
- H. Brass reducer fitting

SET REGULATOR PRESSURE

The *Purge fill* and *Cycle fill* pressures are specified in the Method. Set the regulator pressure at the higher of the two, plus 2.0 psig (14 kPag).

For example: If the *Purge fill* pressure is set to 19.500 psig (134.45 kPag) and the *Cycle fill* pressure as 19.000 psig (131.00 kPag), set the regulator pressure at 21.500 psig (148 kPag). Do not set the regulator above 22 psig (152 kPag).

RECOVER FROM A POWER FAILURE

If an analysis was in progress when a power failure occurred, completed cycles will be saved. The instrument is vented on startup to ensure that it is in a safe state.



Even though the instrument saves data during a power failure, any operation should be restarted to ensure complete results.

POWER INSTRUMENT ON AND OFF



This instrument does not have a power switch and must be disconnected from the wall outlet when powering off; therefore it is important to position the instrument where the wall outlet is easily accessible.

When the analyzer is powered on, after a few seconds, the system vents automatically. Allow approximately 30 minutes for temperature stabilization before performing analyses. For analyses that require very precise results, allow the analyzer to warm a minimum of two hours.

Wait a minimum of 30 seconds between powering off and powering on the instrument.

PARTS AND ACCESSORIES

Parts and accessories are located on the [Micromeritics](#) web page.

A EXPORT DATA



Due to continuous improvements, the specific export format is subject to change without notice.

1. Tap **Export** on screen with the Export option.
2. In the Export box, select to export to either a USB or network drive.
3. Select USB if the data will be exported to a USB drive. If USB is not selected, the file is automatically exported to the configured network path.
4. Choose the format type (such as PDF, XLSX, Raw or TXT).

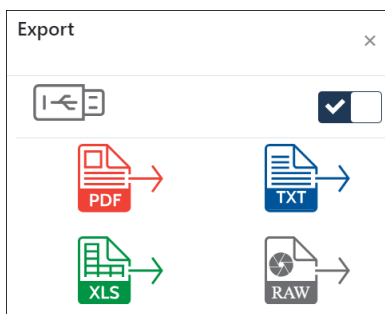

PDF

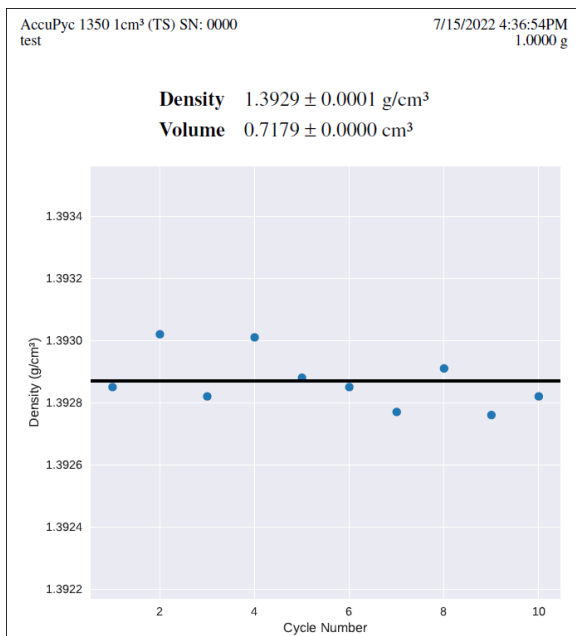

XLSX

	A	B
1	AccuPyc 1350 1cm ³ (TS) SN: 0000	7/15/2022 4:36:54PM
2	test	1.0000 g
3		
4	Density	1.3929 ± 0.0001 g/cm ³
5	Volume	0.7179 ± 0.0000 cm ³
6		
7		
8	Density	
9	Cycle Number	Density (g/cm ³)
10		1 1.39285
11		2 1.39302
12		3 1.39282
13		4 1.39301
14		5 1.39288
15		6 1.39285
16		7 1.39277
17		8 1.39291
18		9 1.39276
19		10 1.39282

RAW XLSX

	A	B
1	Instrument	AccuPyc 1350 1cm ³ (TS) SN: 0000
2	Start time	7/15/2022 4:36:54PM
3	Description	test
4	Mass	1.0000 g

TXT

```

AccuPyc 1350 1cm³ (TS) SN: 0000 7/15/2022 4:36:54PM
test 1.0000 g

Density 1.3929 ± 0.0001 g/cm³
Volume 0.7179 ± 0.0000 cm³

Density
Cycle Number Density (g/cm³)
1 1.39285
2 1.39302
3 1.39282
4 1.39301
5 1.39288
6 1.39285
7 1.39277
8 1.39291
9 1.39276
10 1.39282

AccuPyc 1350 1cm³ (TS) SN: 0000 7/15/2022 4:36:54PM
test 1.0000 g

Volume Dev Density Dev Time Temperature
(cm³) (cm³) (g/cm³) (g/cm³) (mm:ss) (°C)
-----
1 0.7180 0.0000 1.3928 -0.0000 06:40 19.999
2 0.7179 -0.0001 1.3930 0.0001 08:43 19.995
3 0.7180 0.0000 1.3928 -0.0000 10:42 19.994
4 0.7179 -0.0001 1.3930 0.0001 12:52 19.994
5 0.7179 -0.0000 1.3929 0.0000 15:06 19.997
6 0.7180 0.0000 1.3928 -0.0000 17:05 19.995
7 0.7180 0.0000 1.3928 -0.0001 19:06 19.997
8 0.7179 -0.0000 1.3929 0.0000 21:07 19.997
9 0.7180 0.0001 1.3928 -0.0001 23:05 19.998
10 0.7180 0.0000 1.3928 -0.0000 25:07 19.999

AccuPyc 1350 1cm³ (TS) SN: 0000 7/15/2022 4:36:54PM
test 1.0000 g

Method
Name: Standard [1]
Gas: Helium
Temperature: 20.000 °C
Cup: Cup
Fill direction: Reference Chamber
Use vacuum preparation: No
Purge fill pressure: 6.000 psig
Purges: 10
Cycle fill pressure: 6.000 psig
Cycles: 10
End by: Rate
Rate: 0.0050 psig/min
Record P1 equilibration data: Yes
Record first: 5 cycles
Record last: 500 points
Record P2 equilibration data: Yes
Record first: 5 cycles
Record last: 500 points
    
```

**This page
intentionally
left blank**

B VOLUME CHANGE WITH TEMPERATURE

Most materials expand when heated. This is true of many sample materials and also for the metal analysis blocks of the AccuPyc. The AccuPyc software automatically corrects for the change in sample and reference volume with temperature. If correction of the sample volume is needed, the calculation below can be applied to the volume reported by the instrument. The verification standard shipped with the instrument has negligible expansion over the temperature range of the instrument, so no correction is necessary for that object.

The degree of linear expansion for a material is described by its coefficient of thermal expansion or CTE. CTE is commonly expressed in units of $10^{-6}/K$. Values for some common materials are shown below.

<u>Material</u>	<u>CTE ($10^{-6}/K$)</u>
Tungsten Carbide	5.9
440 Stainless Steel	10.1
6061 Aluminum	23.4

The volume that results from thermal expansion is calculated as:

$$V = V_0(1 + 3\alpha(T - T_0))$$

where:

V is the volume at the new temperature
 V_0 is the volume at the original temperature
 α is the coefficient of thermal expansion
 T is the new temperature
 T_0 is the original temperature

For example, consider a 440 stainless steel object with a volume of 10 cm^3 at $20 \text{ }^\circ\text{C}$. At $60 \text{ }^\circ\text{C}$, the volume is:

$$V = 10 \text{ cm}^3(1 + 3 \times 10.1 \times 10^{-6} \times 40)$$

$$V = 10.0121 \text{ cm}^3$$

**This page
intentionally
left blank**

C ERROR MESSAGES

Block temperature is unresponsive to cooling after applying current below [n] A for [n] s. Starting temp.: [n] °C, current temp.: [n] °C.

Block temperature is unresponsive to heating after applying current above [n] A for [n] s. Starting temp.: [n] °C, current temp.: [n] °C.

[n] temperature too high, above [n] °C.

Cause: An internal processing and/or hardware error has occurred. The instrument automatically turns off the TEC as a safety precaution.

Action: Cycle power. Contact your Micromeritics Service Representative if this error message continues.

Cannot actuate hardware. No communications with the PCB.

Cannot communicate with the instrument hardware.

Cannot connect to instrument hardware.

Cannot get communications attributes.

Cannot get the PCB Status.

Cannot install software file: [n]

Cannot reach server [n]: [n]

Cannot save copy.

Cannot set communications attributes.

Cannot start an operation. No communications with the PCB.

Could not fetch results.

Error generating PDF file for report.

Error generating plot for PDF report.

Error logger cannot be initialized. Error code [n]. Program will terminate.

Hardware error. Unable to set temperature.

Hardware PCB Error: [n]

Cause: An internal processing and/or hardware error has occurred.

Action: Cycle power. Contact your Micromeritics Service Representative if this error message continues.

Cannot export to USB. Multiple USB drives found.

Cause: Multiple USB drives are plugged in.

Action: Unplug the other USB drives.

Cannot export to USB. No USB drive found.

Cause: USB drive is not plugged in.

Action: Plug in USB drive.

Cannot parse report on [n]: [n]

Cause: The instrument detected an incorrect analysis report format when it tried to import the report from an AccuPyc legacy instrument.

Action: Contact your Micromeritics Service Representative.

Cannot run [n] without an existing calibration.

Cause: The instrument has not completed any Volume Calibrations.

Action: Contact your Micromeritics Service Representative.

Equilibration was not achieved after [n] s. [n] canceled.**P0 equilibration was not achieved after [n] s. [n] canceled.****P1 equilibration was not achieved after [n] s. [n] canceled.****P2 equilibration was not achieved after [n] s. [n] canceled.****Pressure equilibration for venting was not achieved after [n] s. [n] canceled.**

Cause: The sample being analyzed failed to equilibrate.

Action A: Ensure the sample is properly prepared before performing an analysis.

Action B: Some samples absorb helium slowly (foams, organics, etc.). Set the Equilibration Rate to progressively higher values until reasonable equilibration times (15 sec to 120 sec) are achieved.

Action C: If Pressure Stabilization is set to Time, set the Interval to less than 999 seconds.

Action D: Check the instrument for gas leaks following the instructions in the operator manual.

Action E: Contact your Micromeritics Service Representative if this error message continues.

Error printing PDF file for report.

Cause A: Printer is not connected to the network.

Action A: Contact your IT department and ensure you can print from other computers on the same network.

Cause B: Instrument is not connected to the network. Or, it is connected to a different network than the printer.

Action B: If the printer type is Wi-Fi, go to the TCP/IP screen and ensure the correct Wi-Fi network is selected. Otherwise, contact your IT department. If the instrument is on the network, you should be able to connect to it remotely as described in the operator manual.

Cause C: The instrument does not have appropriate permissions.

Action C: Contact your IT department to change instrument permissions.

Cause D: An internal processing and/or hardware error has occurred.

Action D: Contact your Micromeritics Service Representative.

Last measured atmospheric pressure is [n]. Possible vent valve failure or vent blockage.

Cause: Vent valve failure or Vent Port blockage. This can manifest as a high atmospheric pressure measurement, which causes a failure to fill to the requested gauge pressure.

Action A: Ensure the Vent Port on the back of the unit is clear of dust and other obstructions.

Action B: Contact your Micromeritics Service Representative if this error message continues.

Maximum evacuation time ([n] s) exceeded. [n] canceled.

Cause: The target vacuum pressure could not be reached during vacuum preparation.

Action A: Ensure the vacuum pump is attached and running.

Action B: Check the instrument for gas leaks following the instructions in the operator manual.

Action C: Contact your Micromeritics Service Representative if this error message continues.

Maximum fill time ([n] s) exceeded. [n] canceled.

Cause: There was insufficient pressure to allow filling.

Action A: Increase the regulator pressure, or, if there is insufficient gas in the tank, obtain a new tank. Tank pressure should be at least 200 psi above regulator pressure.

Action B: Check the instrument for gas leaks following the instructions in the operator manual.

Action C: Contact your Micromeritics Service Representative if this error message continues.

No legacy instrument at the address.

Cause A: The IP address is incorrect.

Action A: Ensure the IP address matches the IP address on the legacy instrument's screen.

Cause B: Legacy instrument is not connected to the network (if you are connecting both instruments to the lab network).

Action B: Contact your IT department and ensure you can connect to the legacy instrument from other computers on the same network.

Cause C: Instrument is not connected to the network (if you are connecting both

instruments to the lab network). Or, it is connected to a different network than the legacy instrument.

Action C: Contact your IT department. If the instrument is on the network, you should be able to connect to it remotely as described in the operator manual.

Cause D: The instrument is not directly connected to the legacy instrument.

Action D: Connect them by plugging an Ethernet cable into the appropriate ports as described in the operator manual. Cycle power on both instruments.

Cause E: An internal processing and/or hardware error has occurred.

Action E: Contact your Micromeritics Service Representative.

No printer available.

Cause A: No printer is connected to the network.

Action A: Contact your IT department and ensure you can print to at least one printer from other computers on the same network.

Cause B: Instrument is not connected to the network. Or, it is connected to a different network than the printer.

Action B: Contact your IT department. If the instrument is on the network, you should be able to connect to it remotely as described in the operator manual.

Cause C: The instrument does not have appropriate permissions.

Action C: Contact your IT department to change instrument permissions.

Cause D: An internal processing and/or hardware error has occurred.

Action D: Contact your Micromeritics Service Representative.

Other operations did not finish after [n] s. [n] canceled.

Cause: Background operations did not finish, so the desired operation cannot be started.

Action: Cycle power. Contact your Micromeritics Service Representative if this error message continues.

Pressure overrange [n] detected. [n] canceled.

Cause: Pressure reading is above normal operating range, so the operation was canceled.

Action A: Adjust the regulator pressure so that it is no greater than 22 psig (152 kPag).

Action B: Contact your Micromeritics Service Representative if this error message continues.

Software update no longer accessible.

Cause A: If you are installing from a USB drive with installation files provided by Micromeritics, it may be unplugged or no longer contain the correct data.

Action A: Ensure the USB drive is plugged in. It should have a '1350' folder on its top level. The '1350' folder should contain a version folder (such as 'v1.0.0'). The version folder should contain at minimum a 'mic-instrument' file and a file with a '.deb' extension.

Cause B: The software version has already been installed.

Action B: Go to the About screen and note the Software Version. Contact your Micromeritics Software Representative to ask if this is the latest version.

Cause C: An internal processing and/or hardware error has occurred.

Action C: Contact your Micromeritics Service Representative.

This calibration is too different from the factory calibration and cannot be saved. Make sure you did not use a cup.**This calibration is too different from the previous calibration and cannot be saved.****Make sure you did not use a cup.**

Cause A: Calibration was run with a cup in the sample chamber, which is not the standard procedure.

Action A: Re-run the calibration without a cup in the sample chamber. Contact your Micromeritics Service Representative if this error message continues.

Cause B: An incorrect volume standard was selected.

Action B: Make sure **Settings > Inserts on page 2 - 31 > Volume Standard** includes an entry for the standard used for calibration. Be sure to select that entry before starting calibration. Contact your Micromeritics Service Representative if this error message continues.

Cause C: The instrument's gas selection does not match the gas connected.

Action C: Select the gas in **Settings > Calibration > Calibration on page 2 - 35**. Contact your Micromeritics Service Representative if this error message continues.

Cause D: Debris has accumulated in the sample chamber.

Action D: Clean the sample chamber. Refer to the instrument Operator's Manual. Contact your Micromeritics Service Representative if this error message continues.

Unable to achieve stable temperature at [n]. [n] canceled.

- Cause A:* The sample cap was left open. This means the instrument is more exposed to ambient temperature changes and water vapor accumulating in the chamber.
- Action A:* Keep the sample cap closed and screwed tight at all times, except when inserting or removing samples.
- Cause B:* Airflow is obstructed.
- Action B:* Ensure that the back of the instrument is not obstructed by cables or debris. Ensure that the fan is running. Ensure that the area behind the fan grille is clear and that the fan grille is clear of dust. Ensure that the air intake filters at the rear of the instrument are not clogged. Rinse or replace them if they are clogged.
- Cause C:* The specified environmental conditions are not met.
- Action C:* See operating manual for environmental specifications, in particular, the room's ambient temperature and its maximum rate of change per hour. Ensure that the instrument is installed away from exposure to direct sunlight and direct air drafts such as heating or air conditioning vents. Check with a digital thermometer if the room's climate control system cycles temperature up and down at a rate above the specified limit.
- Cause D:* There is a hardware problem or temperature control software got into an unanticipated state.
- Action D:* To reset the temperature control software, cycle power or set a different analysis temperature (for ATC instruments). Contact your Micromeritics Service Representative if this error message continues.

Unable to connect to network printer.

- Cause A:* The entered parameters are incorrect.
- Action A:* Contact your IT department and ensure all parameters are correct.
- Cause B:* Printer is not connected to the network.
- Action B:* Contact your IT department and ensure you can print from other computers on the same network.
- Cause C:* Instrument is not connected to the network. Or, it is connected to a different network than the printer.
- Action C:* Contact your IT department. If the instrument is on the network, you should be able to connect to it remotely as described in the operator manual.
- Cause D:* The instrument does not have appropriate permissions.
- Action D:* Contact your IT department to change instrument permissions.
- Cause E:* An internal processing and/or hardware error has occurred.
- Action E:* Contact your Micromeritics Service Representative.

Unable to connect to Wi-Fi.

Cause A: The password is incorrect.

Action A: Contact your IT department and ensure the password is correct.

Cause B: The Wi-Fi network is inactive or has low signal strength near the instrument.

Action B: Contact your IT department and ensure the network is active and has adequate signal strength near the instrument.

Cause C: The instrument does not have appropriate permissions.

Action C: Contact your IT department to change instrument permissions.

Cause D: An internal processing and/or hardware error has occurred.

Action D: Contact your Micromeritics Service Representative.

Unable to mount network drive.

Cause A: The entered parameters are incorrect.

Action A: Contact your IT department and ensure all parameters are correct.

Cause B: Network drive is not connected to the network.

Action B: Contact your IT department and ensure you can connect to the network drive from other computers on the same network.

Cause C: Instrument is not connected to the network. Or, it is connected to a different network than the network drive.

Action C: Contact your IT department. If the instrument is on the network, you should be able to connect to it remotely as described in the operator manual.

Cause D: The instrument does not have appropriate permissions.

Action D: Contact your IT department to change instrument permissions.

Cause E: An internal processing and/or hardware error has occurred.

Action E: Contact your Micromeritics Service Representative.

Warning: Could only achieve pressure of [n] when trying to reach [n].

Cause: The operation could only fill to 95% of the specified gauge pressure. The operation is allowed to continue. If desired, perform the actions below.

Action A: Increase the regulator pressure, or, if there is insufficient gas in the tank, obtain a new tank. Tank pressure should be at least 200 psi above regulator pressure.

Action B: Check the instrument for gas leaks following the instructions in the operator manual.

Action C: Contact your Micromeritics Service Representative if this error message continues.

**This page
intentionally
left blank**

D MICROACTIVE

This feature provides a quick and easy way to investigate and manipulate analysis data using a variety of reporting methods.

When a report is opened, plots and summary data are displayed, and in some reports certain parameters are also displayed. Plots may be edited by selecting the data points or data point range to be included in the plots and modifying the parameters. When a report is edited, the results are immediately reflected in the plots and summary data.

The MicroActive software includes a report system which allows you to manipulate and customize reports.

1. Launch the MicroActive application.
2. From the **File** menu, select **Import > AccuPyc**.
3. In the Download Results from Instruments dialog box, do the following:
 - a. Type the IP address of the 1350 instrument from which to download results. This instrument must be connected to the network through the LAB NET port on the back of the instrument.
 - b. Click **Add**.
 - c. Repeat the process to add the results for any additional instruments.
 - d. To remove an entry, select the entry and click **Remove**.
 - e. In the *Download Directory* field, enter a path or use the Browse button to locate a destination for the sample files.
 - f. Click **Download**. If the download is complete, the URL field displays, "Download complete." If an error occurs, an information message displays indicating that the files cannot be downloaded.

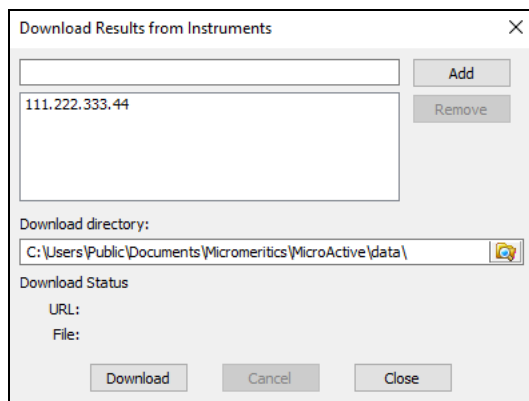

VIEW THE SAMPLE FILE

Either open the sample from the download location or use the **File > Open** menu option and select the file.

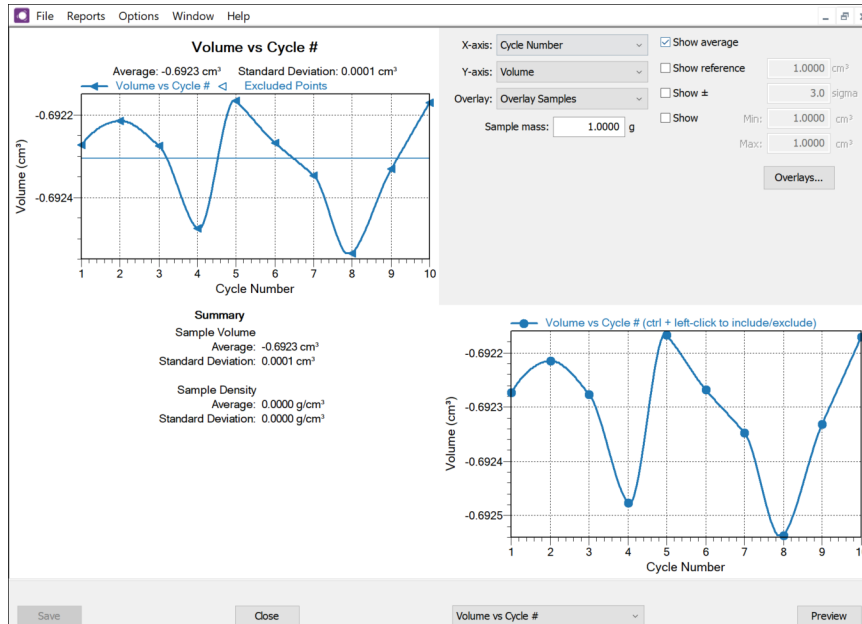

DATA MANIPULATION

X-axis: Cycle Number Show average

Y-axis: Volume Show reference 1.0000 cm³

Overlay: Overlay Samples Show ± 3.0 sigma

Sample mass: 1.0000 g Show Min: 1.0000 cm³

Max: 1.0000 cm³

Overlays...

Use the options in the upper right to:

- Edit the X and Y axis.
- Apply an Overlay.
- Specify a sample mass.
- Show Average, Reference, Sigma and Min/Max and the specific values.

When ranges are edited, the changes are reflected immediately in the plots and the summary data displayed in the window.

OVERLAYS

When Overlay Samples is selected, click the **Overlays** button to select which sample files to include in the overlay.

Overlays

Selection	Description
Status	Selects the status of files to be combined.
Look in	Changes the file folder location. Click the Browse icon.
Available Files	Lists files that meet the selected criteria. Select the files to be combined, then click Add . The selected files are moved to the <i>Selected Files</i> list box.
Selected Files	Lists the files selected to be combined. Click Remove to move a file back to the <i>Available Files</i> list box. Click OK to combine the files.

OTHER FUNCTIONS

- To preview the reports selected, click **Preview**.
- Change the option presentation of the sample description window to either *Basic* or *Advanced* to modify certain file parameters.

OPTION PRESENTATION DISPLAY

Use to change the way sample files and parameter files display, either *Basic* or *Advanced*.

- **Basic** displays sample information in a single window. This display option is used after the parameter files have been created. The previously entered or default parameter files are then accessible using drop-down lists.
- **Advanced** displays all parts of sample and parameter files. Navigate to parameter windows by selecting the tabs across the top of the window: *Sample Description*, *Analysis Conditions* or *Report Options*.

**This page
intentionally
left blank**



EU DECLARATION OF CONFORMITY

This declaration of conformity is issued under the sole responsibility of the manufacturer:

Micromeritics Instrument Corporation
4356 Communications Drive
Norcross, GA 30093, USA

Hereby declares that the product:

AccuPyc III Automatic Gas Pycnometer

is in conformity with the following **EU harmonization legislation**:

2014/35/EU - LVD Directive
2014/30/EU - EMC Directive
2011/65/EU - RoHS Directive

and that the equipment is in conformity with the following harmonized and other appropriate standards;

2014/35/EU (LVD)

IEC 61010-1:2010/AMD:2016 - Safety requirements for electrical equipment for measurement, control, and laboratory use — Part 1: General requirements.

EN 61010-2-010:2019 - Particular requirements for laboratory equipment for the heating of materials.

IEC 61010-2-081:2019 – Particular requirements for automatic and semi-automatic laboratory equipment for analysis and other purposes.

2014/30/EU (EMC)

IEC 61326-1:2020 Ed.3 - Electrical equipment for measurement, control and laboratory use — EMC requirements — Part 1: General requirements

IEC 61000-3-2:2018 /AMD1:2020 - Part 3-2: Limits — Limits for harmonic current emissions (equipment input current ≤ 16 A per phase)

IEC 61000-3-3:2013 - Part 3-3: Limits — Limitation of voltage changes, voltage fluctuations and flicker in public low-voltage supply systems, for equipment with rated current ≤ 16 A per phase and not subject to conditional connection

2011/65/EU (RoHS)

EN 63000:2018 - Technical documentation for the assessment of electrical and electronic products with respect to the restriction of hazardous substances

Name: **John McCaffrey, Ph.D.**

Title: **Vice President, R & D**

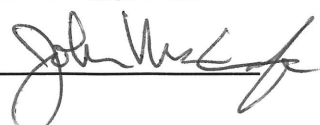
Signature: 

Date of issue: **05/19/2023**

Location: **Norcross, GA USA**



UK DECLARATION OF CONFORMITY

This declaration of conformity is issued under the sole responsibility of the manufacturer:

Micromeritics Instrument Corporation
4356 Communications Drive
Norcross, GA 30093, USA

Hereby declares that the product:

AccuPyc III Automatic Gas Pycnometer

is in conformity with the following UK legislation:

Electrical Equipment (Safety) Regulations 2016
Electromagnetic Compatibility Regulations 2016
Restriction of the Use of Certain Hazardous Substances in E&E Equipment Regulations 2012

and that the equipment is in conformity with the following designated and other appropriate standards;

Electrical Equipment (Safety) Regulations 2016

IEC 61010-1:2010/AMD1:2016 - *Safety requirements for electrical equipment for measurement, control, and laboratory use — Part 1: General requirements.*

EN 61010-2-010:2019 - *Particular requirements for laboratory equipment for the heating of materials.*

IEC 61010-2-081:2019 – *Particular requirements for automatic and semi-automatic laboratory equipment for analysis and other purposes.*

Electromagnetic Compatibility Regulations 2016

IEC 61326-1:2020 - *Electrical equipment for measurement, control and laboratory use — EMC requirements — Part 1: General requirements*

IEC 61000-3-2:2019 - *Part 3-2: Limits — Limits for harmonic current emissions (equipment input current ≤ 16 A per phase)*

IEC 61000-3-3:2013 - *Part 3-3: Limits — Limitation of voltage changes, voltage fluctuations and flicker in public low-voltage supply systems, for equipment with rated current ≤ 16 A per phase and not subject to conditional connection*

Restriction of the Use of Certain Hazardous Substances in E&E Equipment Regulations 2012

EN 63000:2018 - *Technical documentation for the assessment of electrical and electronic products with respect to the restriction of hazardous substances*

Name: John McCaffrey, Ph.D.

Title: Vice President, R & D

Signature: _____

Date of issue: 05/19/2023

Location: Norcross, GA USA